

INFORMATION FOR FIRST AND SECOND RESPONDERS

EMERGENCY RESPONSE GUIDE



Cadillac Celestiq

5 Door Sedan

All Wheel Drive

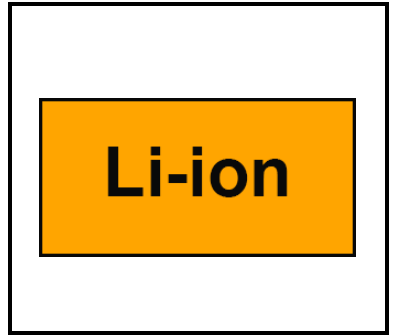

CONTENTS

0. Rescue Sheet	Page	3
1. Identification / recognition	Page	4
2. Immobilization / stabilization / lifting	Page	5
3. Disable direct hazards / safety regulations	Page	6
4. Access to the occupants	Page	8
5. Stored energy / liquids / gases / solids	Page	10
6. In case of fire	Page	11
7. In case of submersion	Page	11
8. Towing / transportation / storage	Page	12
9. Important additional information	Page	13
10. Explanation of pictograms used	Page	13

0. Rescue Sheet

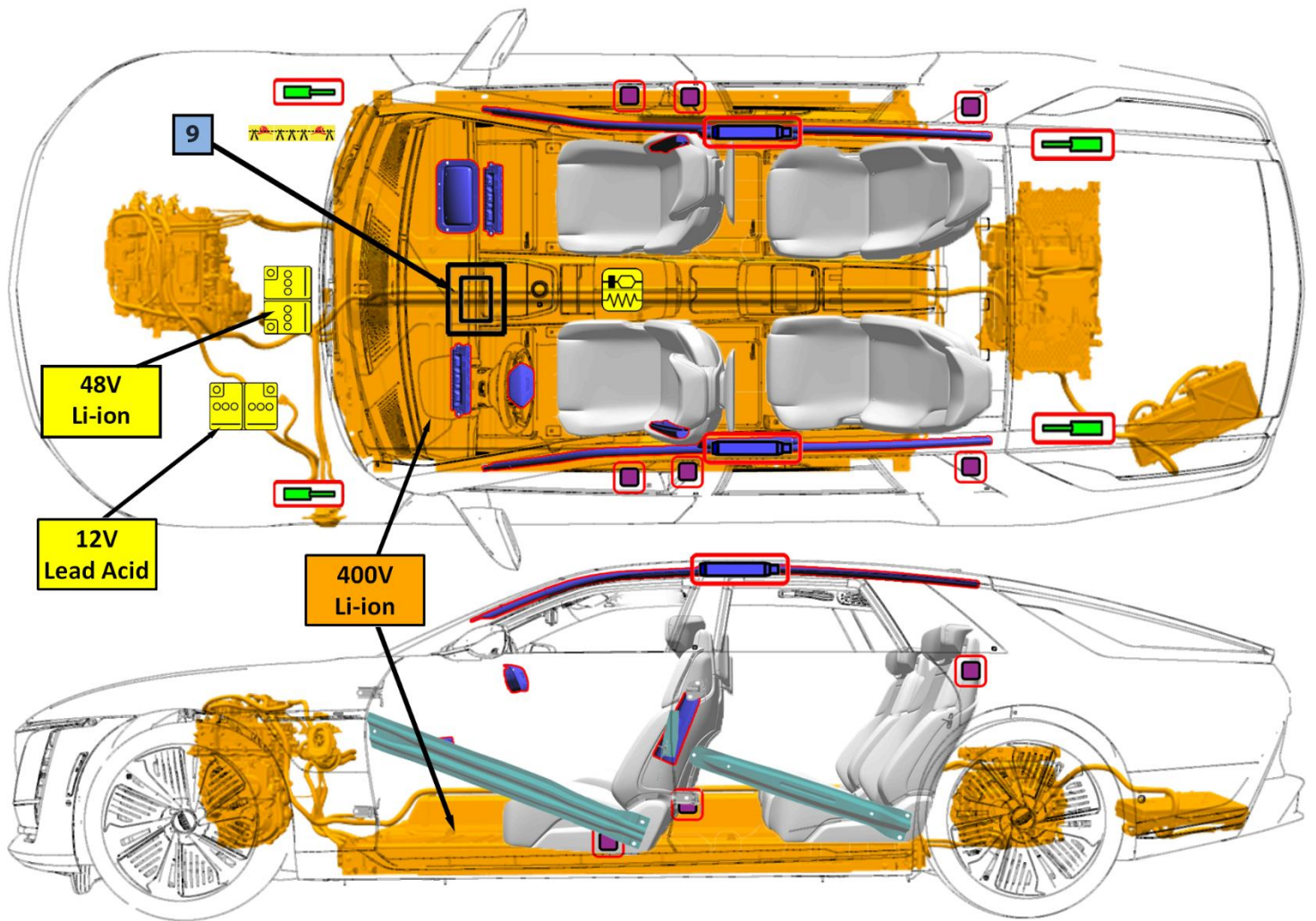

1. Identification / recognition



Advise Dispatch and all responders that an electric vehicle is involved.



Lack of engine noise does not mean vehicle is off: vehicle movement capability exists until vehicle is fully shut down. Always wear appropriate PPE.

Emblems and Badging

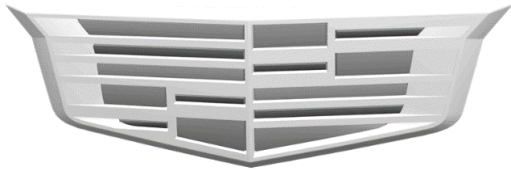

The Cadillac Crest appears on the front grille area and the rear liftgate.



High Voltage Battery Information

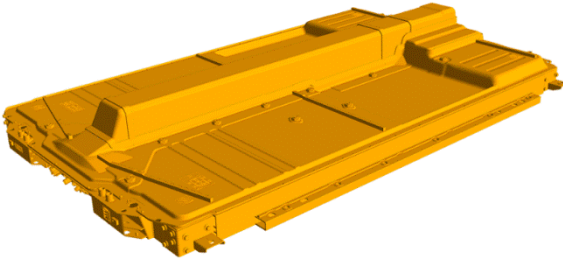

The battery is a High Voltage (Class B) Li-ion pack, that is mounted under the vehicle and is a structural part of the floor pan.



Battery Warning Label

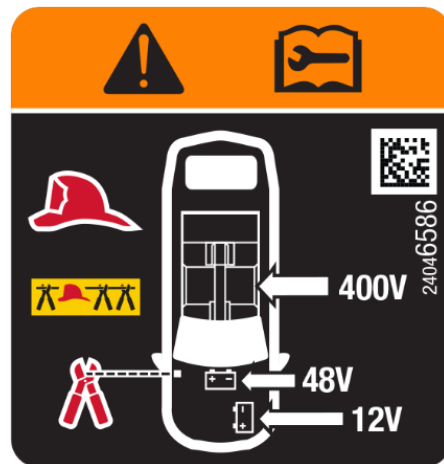
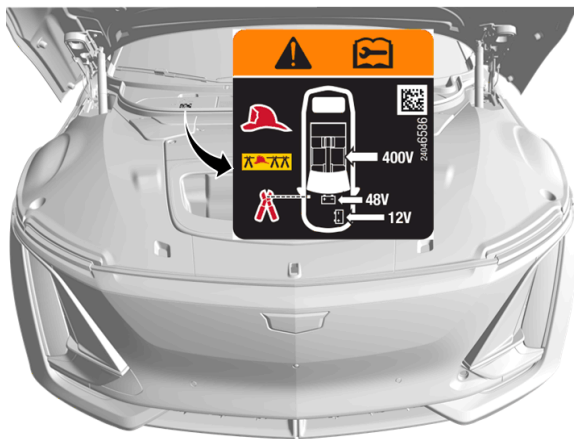

2. Immobilization / stabilization / lifting



IMMOBILIZE VEHICLE

- Block the wheels.
- Follow procedures for conventional vehicles.

Electric Parking Brake (EPB)



Applying the Electric Parking Brake

Press the EPB switch momentarily. The red parking brake status light will flash and then stay on once the EPB is fully applied.

Releasing the Electric Parking Brake

1. Turn the vehicle on.
2. Apply and hold the brake pedal.
3. Press the EPB switch momentarily.

The EPB is released when the red parking brake status light is off.

Electric Drive Unit Shift Lever

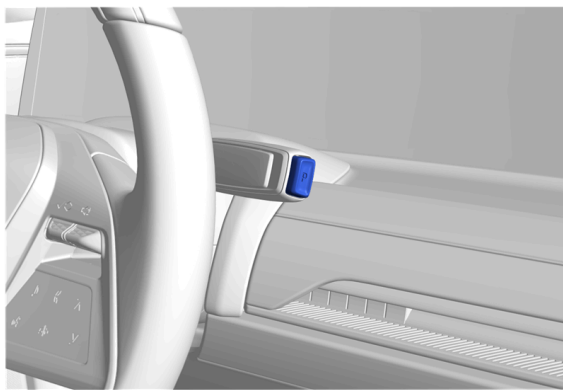

Shifting into Park

Press the button at the end of the shift lever to shift to P (Park).



Hands-Free Start

This vehicle does NOT have a power button. The vehicle will turn off when shifted to P (Park), seat belt is unbuckled, and the door is opened for driver's exit.

A "Vehicle Off" symbol will appear on the infotainment display and can be used to turn the vehicle off. If a collision is detected, an additional emergency vehicle off display will be shown and can be pressed to turn the vehicle off. Refer to Section 3 for additional details.



Lifting Points

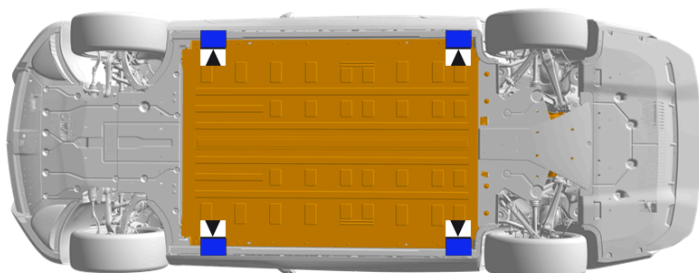

There are features on the body of the vehicle, for use as primary lifting points.

Do NOT lift the vehicle from any locations on the high voltage battery.

3. Disable direct hazards / safety regulations

Thermal Runaway Alert and Mitigation



The vehicle is equipped with a 12v battery management system with internal fault detection, including thermal runaway alert and mitigation for the high voltage battery.

To keep thermal runaway alert and mitigation available, DO NOT disable the 12v battery.

Automatic safety systems are enabled when low voltage power is available.

12v power is required for the high voltage battery management system to operate. The system is designed to detect internal faults and, if necessary, activate thermal runaway mitigation. A “Battery Danger Detected, Safely Exit Vehicle” notification may be displayed on the instrument panel with additional information, an OnStar call may be attempted to be placed and the horn, chime, and hazard lights may activate. OnStar advisors are trained to contact first responders.

DO NOT disable the 12v battery to disable the horn.



Hands-Free Start

Powering Off

When the drive cycle has been completed and the vehicle is shifted to P (Park), the vehicle will turn off once the seat belt is unbuckled, and the door is opened for driver’s exit.

The vehicle can also be turned off by pressing the “Vehicle Off” symbol on the infotainment display.

If the vehicle has not been shifted out of P (Park), it will not turn off based on driver exit detection and will need to be turned off by pressing the “Vehicle Off” symbol or waiting for the automatic shutdown timeout.

If a collision is detected, an additional emergency vehicle off icon will appear on the display and can be pressed to turn the vehicle off.



The high voltage system can remain energized even when the vehicle is in the OFF state.



Outside Access to Hood Release

Power Operation (Presence Detection Mode)

In this hands-free mode, the hood will open automatically when the remote key is within 1 m (3 ft) of the front fascia to operate the power hood.

NOTE: Presence Detection Mode will not function if the feature is not enabled.



Inside Access to Hood Release

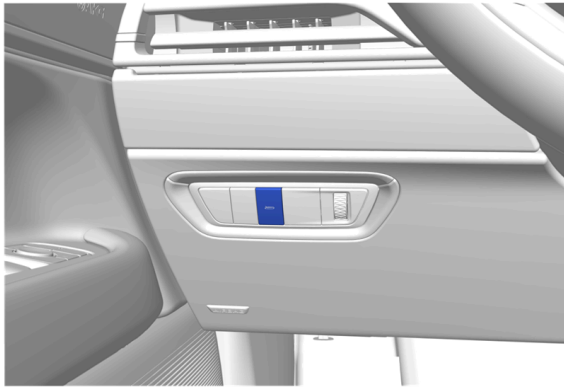

Power Operation

To open the hood, press the button on the instrument panel to the left of the steering wheel.

To close the hood, press the button and hold until the hood closes.

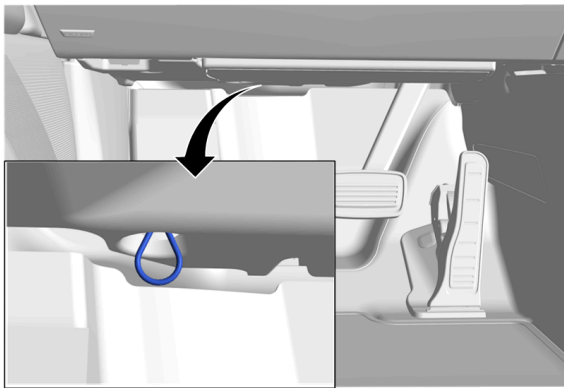

Manual Operation

The Manual Release Cable is located in the driver's footwell.

1. Firmly pull the hood release cable twice to release the hood. It is on the lower left side of the instrument panel.
2. Consider any manipulations of power devices in the vehicle (steering wheel, power seats, windows, etc.) **prior to** cutting the Low Voltage loop.
3. Go to the front of the vehicle and lift the hood open.



First Responder Loop Access

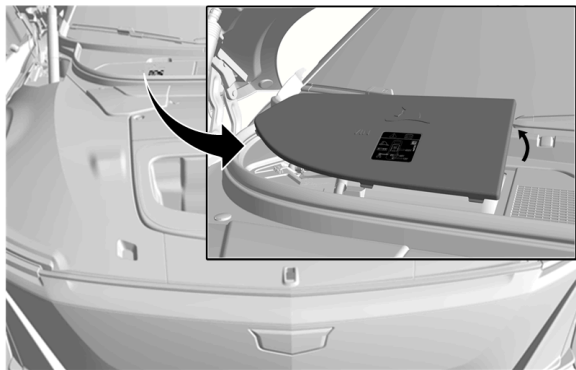

Remove the first responder loop access cover:

1. Lift the rear edge of the access cover up to release the tabs.
2. Rotate the cover up and lift to release the tabs.



First Responder Loop

Double cut the first responder loop on both sides of the yellow tape and remove the cut section of cable from the vehicle. Ensure that the cuts are clean and that there is no risk of loose wires touching.

This cut will disable high voltage.

Airbags can be disabled by removing the 12v battery negative cable. DO NOT disable the 12v battery in the event of a "Battery Danger Detected" notification.

DO NOT CUT ANY ORANGE COLORED HIGH VOLTAGE CABLES.



After disabling the first responder cut loop, wait at least 1 minute to allow high voltage energy to discharge.

VEHICLE AT CHARGE STATION:

If able, terminate charging by removing the charge handle from the vehicle. If enabled, the vehicle's anti-theft alarm may activate. If the charge handle will not release, a manual release loop is located underhood, under an access cover near the left wiper arm.

The common charge handle is shown; Actual charger / vehicle charge inlet may change based on model year and region.

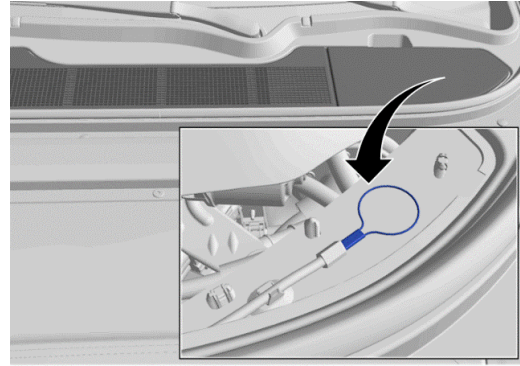
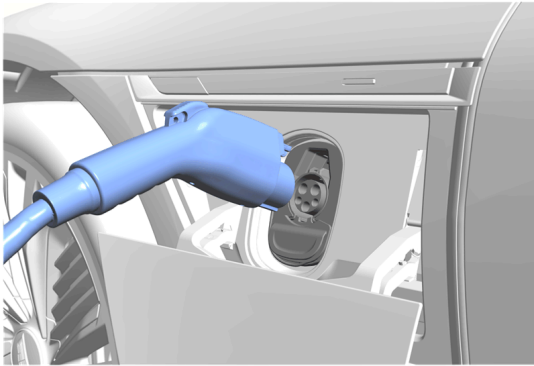

4. Access to the occupants

Refer to the vehicle *Rescue Sheet* for additional illustrations that show the locations of High Strength Structural Components, High Voltage Components, and Safety Components.

Vehicle Glass



The windshield, roof, door windows, rear quarter windows, and rear liftgate window are made of Laminated Glass.



The outer surfaces of the aluminum front roof header and B-pillar are covered with Tempered Glass.

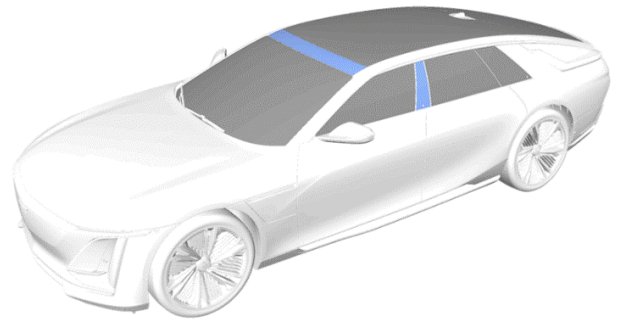

Opening a Door from Outside

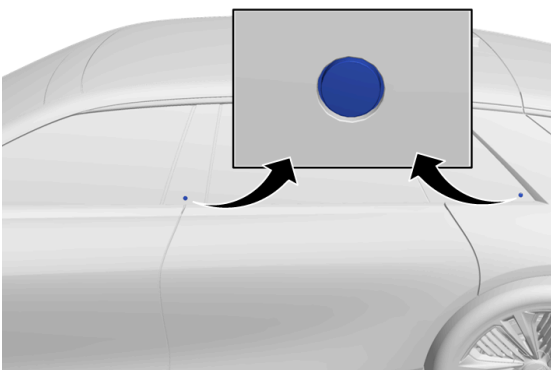

The doors are always power assisted even when being operated manually. The doors will automatically slow down prior to fully opening or closing.

Press one of the exterior door switches. If the door is in motion, press again to stop the door, or to close it if already open and stopped.

Opening a Locked Door from Inside

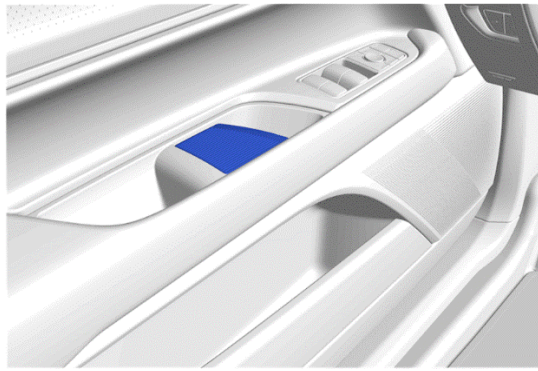

If the doors remain locked, pull **twice** on the inside door handle to gain access to the occupant at each seating location.

NOTE: An alternative method for rear passenger access may be necessary if the rear door child safety locks are engaged.

Steering Column Tilt and Telescoping Control Switch

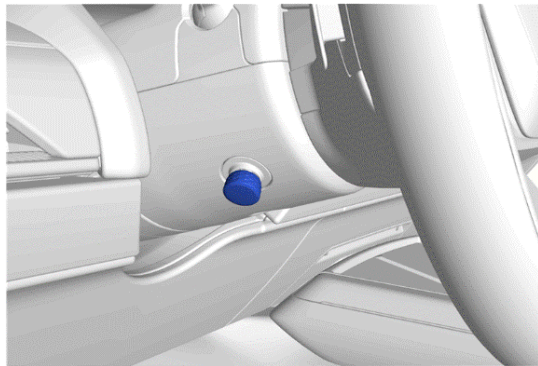

- Press the control up or down to tilt the steering wheel up or down.
- Press the control rearward or forward to move the steering wheel closer or away from you.

Seat Control Switches



The front seat switches function the same for the driver and front seat passenger.

Top Switch

Rotate the switch forward to raise the seatback and rearward to recline the seatback.

Lower Switch

- Move the seat forward or rearward by sliding the control forward or rearward.
- Raise or lower the seat by moving the control up or down.

The rear seat controls are on the rear center display screen.

Occupant Restraint Systems

The CELESTIQ is equipped with eight airbags:

- Driver (Steering Wheel)
- Front Seat Passenger (Instrument Panel)
- (2) Front Knee Bolster Airbags
- (2) Front Seat Outboard Airbags
- (2) Roof Rail Airbags

There are seat belt restraints for four occupants.

The front seat belt system includes two pre-tensioners on each side. The rear seat belt retractors also have pre-tensioners.

The rear seat includes child seat anchor points at the base of the seatback.

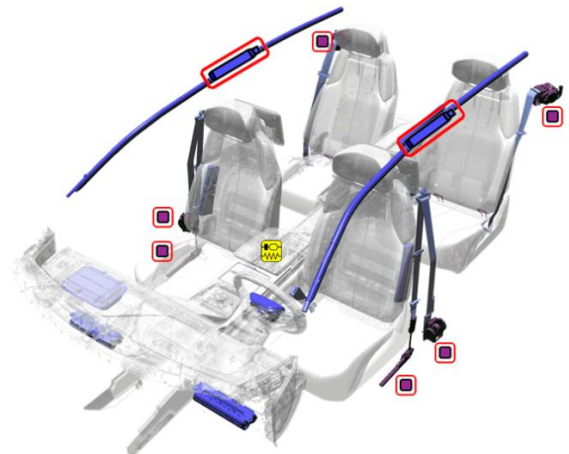

High Strength Steel Content

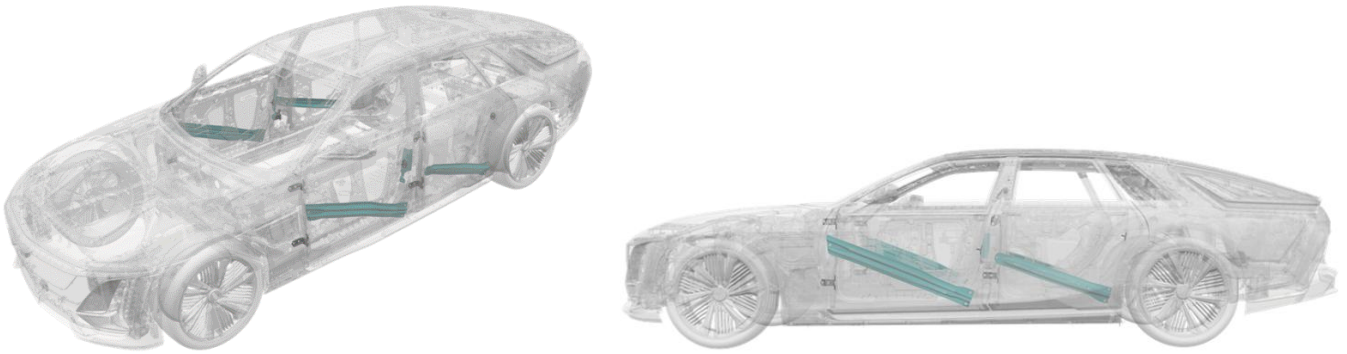

The vehicle structure is made of aluminum. The door reinforcement beams are made of high strength steel.



As with any occupant extrication, exercise caution. The vehicle's high voltage cables and components may be energized with high voltage. Avoid touching or cutting high voltage cables or components during any rescue operation.

5. Stored energy / liquids / gases / solids

12V
Lead Acid

Low Voltage Lead Acid Chemistry Battery

48V
Li-ion

Low Voltage Lithium-Ion Chemistry Battery

400V
Li-ion

High Voltage Lithium-Ion Chemistry Battery



High Voltage Warning, potential for electric shock



Gases emitted from the battery pack are flammable



Gases emitted from the battery pack are toxic











Skin contact may cause irritation. Prolonged contact with electrolyte mixture may result in more severe irritation.

Flush contaminated skin with plenty of water.



Fluids leaking inside the battery pack can become unstable and possibly a risk for fire. Check the battery pack temperature with a thermal imaging camera.

6. In case of fire	
	High Voltage Warning, potential for electric shock
	A battery on fire will not explode
	A battery on fire will not explode. If battery cells reach high enough temperature, they vent and release electrolyte. Battery electrolyte is flammable.
	Gases emitted from the battery pack are toxic
	Skin contact may cause irritation. Prolonged contact with electrolyte mixture may result in more severe irritation. Flush contaminated skin with plenty of water.
	Potential for eye, nose, and throat irritation with prolonged exposure.
	Always wear Self-Contained Breathing Apparatus (SCBA). Use copious amounts of water to cool the battery and to extinguish a fire. Do NOT use an ABC dry chemical extinguisher because it will not extinguish a battery fire.
 	Potential for Battery Re-Ignition.

7. In case of submersion
<p>The high voltage battery is isolated from the vehicle chassis. If the vehicle is immersed in water, there is no risk of electrocution by touching the vehicle.</p> <p>After the vehicle was removed from the water, do the following:</p> <ol style="list-style-type: none"> 1. Allow the vehicle to dry out. 2. Perform the high voltage disabling procedure in Section 3.

8. Towing / transportation / storage

Tow Hooks

Carefully open the cover in the fascia by using the small notch that conceals the tow eye socket.

Install the tow eye into the socket and turn it until it is fully tightened. When the tow eye is removed, reinstall the cover with the notch in the original position.

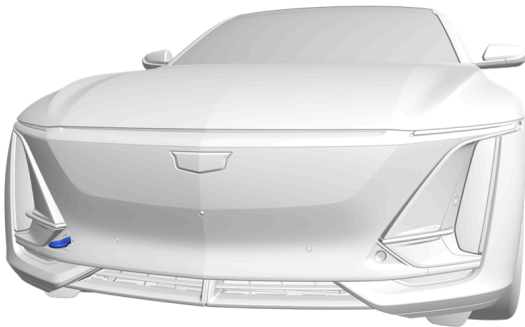

Vehicle Towing and Transportation

General Motors recommends a flatbed carrier to transport a disabled vehicle. A wheel lift truck along with properly rated tow dollies can be used if a flatbed carrier is not available.

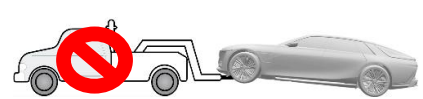
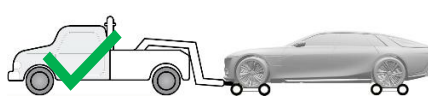
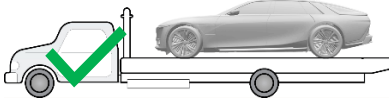

Moving the vehicle with the drive wheels on the ground will generate unwanted energy. Limit the movement of the vehicle to the distance required to prepare the vehicle for towing.



Potential for continued hazards (rekindling/re-gassing/etc) if a damaged vehicle battery is jostled during recovery, including the towing and storage process.



After a "Battery Danger Detected" notification, or thermal runaway mitigation cycle completes, it might be appropriate to wait up to an hour before towing to a certified dealer for vehicle inspection even though evidence of a thermal event such as smoke may not be visible, and unusual odors may not be detected from the vehicle.

Horn Fuse Removal

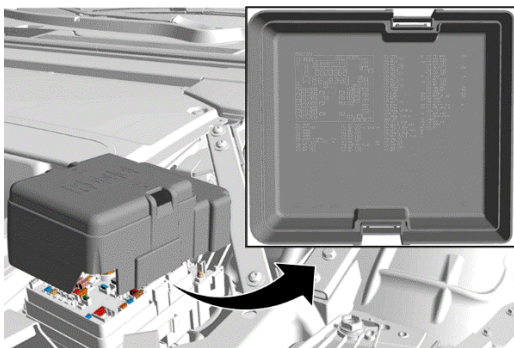

If the horn must be disabled prior to transport, locate and remove the horn fuse from the underhood electrical center.

Post-Crash Vehicle Storage

Store the vehicle outside at a safe distance (15 meters / 50 feet) or separated from flammable objects.

Disposal















The high voltage battery and leaked battery fluids should be properly disposed of according to local regulations. General Motors recommends removing and recycling the battery. Refer to recyclemybattery.com for more information on storing, disabling, removing, and shipping the battery along with a list of available recycling facilities.

9. Important additional information

This vehicle is supported by OnStar, where available.

This vehicle does NOT have a power button. The vehicle will turn off when shifted to P (Park), the seat belt is unbuckled, and the door is opened for driver's exit. The "Vehicle Off" or "Emergency Vehicle Off" symbols will appear on the Infotainment Display and can be used to turn the vehicle off. The "Emergency Vehicle Off" symbol will only appear when a collision is detected.

10. Explanation of pictograms used

	Electric Vehicle		General warning sign		Warning, Electricity
	Battery Technology		Lifting Points		Thermal Imaging Camera
	Flammable		Toxic		Corrosive
	Injury Risk		Use Water		Front Compartment Release
	Power Button		Cable Cut Location		