

INFORMATION FOR FIRST AND SECOND RESPONDERS
EMERGENCY RESPONSE GUIDE

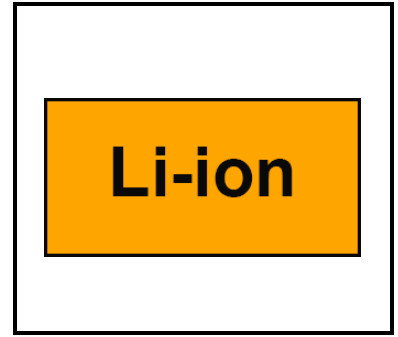

Chevrolet Blazer EV
SUV / 5 Door Hatchback
FWD/RWD/AWD









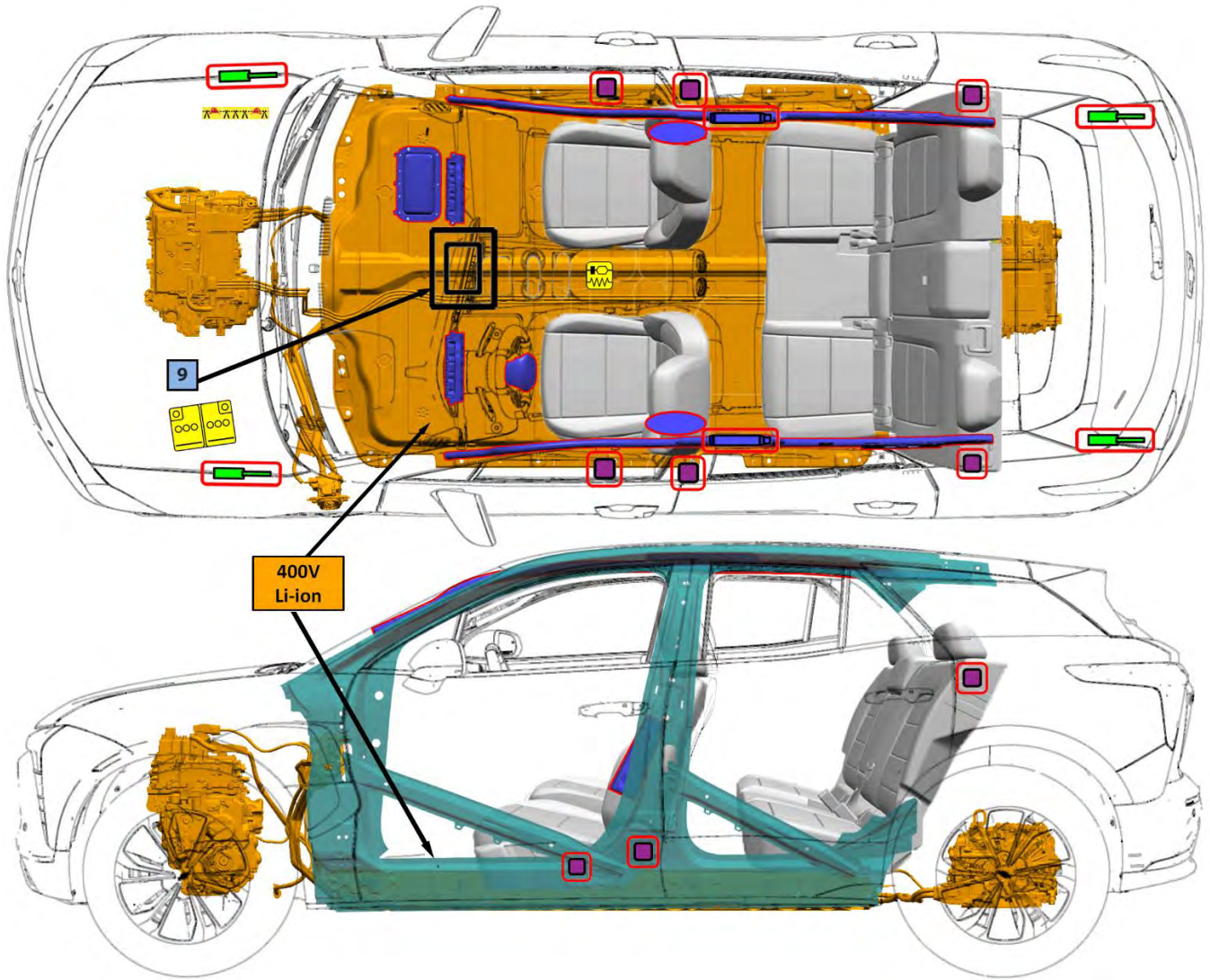



CONTENTS

0. Rescue Sheet	Page	3
1. Identification / recognition	Page	4
2. Immobilization / stabilization / lifting	Page	5
3. Disable direct hazards / safety regulations	Page	6
4. Access to the occupants	Page	8
5. Stored energy / liquids / gases / solids	Page	10
6. In case of fire	Page	11
7. In case of submersion	Page	11
8. Towing / transportation / storage	Page	12
9. Important additional information	Page	13
10. Explanation of pictograms used	Page	13

0. Rescue Sheet



	Airbag		Stored gas inflator		Seat belt pretensioner		SRS control unit		Gas strut/ Preloaded spring
	High strength zone		Zone requiring special attention		Battery low voltage		High voltage battery pack		High voltage power cable component
	Cable Cut Location								

1. Identification / recognition



Advise Dispatch and all responders that an electric vehicle is involved.



Lack of engine noise does not mean vehicle is off: vehicle movement capability exists until vehicle is fully shut down. Always wear appropriate PPE.

Emblems and Badging

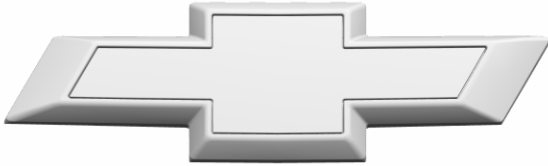

The Chevrolet Logo appears on the hood, fenders, and rear liftgate.



The Blazer EV emblem is on the left side of the liftgate.



High Voltage Battery Information



The battery is a High Voltage (Class B) Li-ion pack, that is a mounted under the vehicle and is a structural part of the floor pan.



Battery Warning Label

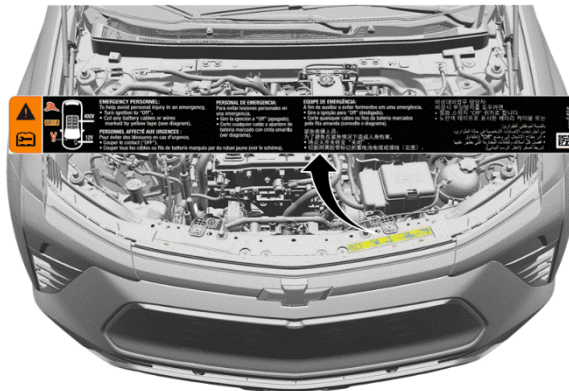

	<p>EMERGENCY PERSONNEL: To help avoid personal injury in an emergency, • Turn ignition to "OFF". • Cut any battery cables or wires marked by yellow tape (see diagram).</p> <p>PERSONNEL AFFECTÉ AUX URGENCES : Pour éviter des blessures en cas d'urgence, • Couper le contact ("OFF"). • Couper tous les câbles ou fils de batterie marqués par du ruban jaune (voir le schéma).</p>	<p>PERSONAL DE EMERGENCIA: Para evitar lesiones personales en una emergencia, • Gire la ignición a "OFF" (apagado). • Corte cualquier cable o alambre de batería marcado con cinta amarilla (ver diagrama).</p>	<p>EQUIPE DE EMERGENCIA: A fim de auxiliar a evitar ferimentos em uma emergência, • Gire a ignição para "OFF" (desligado). • Corte quaisquer cabos ou fios da bateria marcados pela fita amarela (consulte o diagrama).</p> <p>紧急救援人员: 为了避免在紧急情况造成人身伤害, • 将点火开关转到“关闭” • 切割用黄胶带标记的蓄电池电缆或导线。(见图)</p>	<p>비상대비업무 담당자: 비상시 안전방지를 도우려면, • 점화 스위치 "OFF" 위치로 합니다. • 노란색 테이프로 표시된 배터리의 케이블 또는 와이어를 잘라냅니다.</p> <p>بالتسبب الموظفين الطوارئ: للمساعدة في تجنب الإصابة في حالة الطوارئ، • ادر مفتاح التشغيل في وضع "OFF" (مطابق المخطط). • قص أي كابلات أو أسلاك البطارية التي يتم تحديدها بعلامة اصفر.</p> <p>192</p>
--	--	--	--	---

2. Immobilization / stabilization / lifting



IMMOBILIZE VEHICLE

- Block the wheels.
- Follow procedures for conventional vehicles.

Electric Parking Brake (EPB)

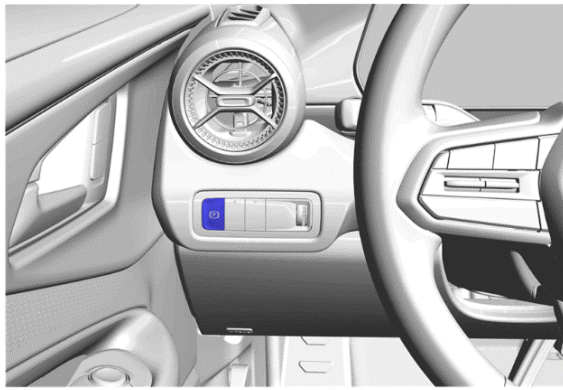

Applying the Electric Parking Brake

Press the EPB switch momentarily. The red parking brake status light will flash and then stay on once the EPB is fully applied.

Releasing the Electric Parking Brake

1. Turn the vehicle on.
 2. Apply and hold the brake pedal.
 3. Press the EPB switch momentarily.
- The EPB is released when the red parking brake status light is off.

Electric Drive Unit Shift Lever

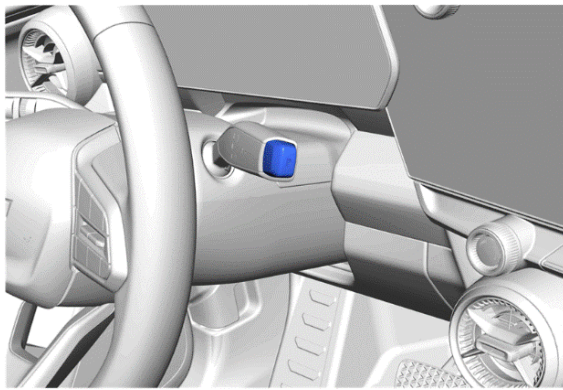

Shifting into Park

Press the button at the end of the shift lever to shift to P (Park).



Hands-Free Start

This vehicle does NOT have a power button. The vehicle will turn off when shifted to P (Park), seat belt is unbuckled, and the door is opened for driver's exit.

A "Vehicle Off" symbol will appear on the infotainment display and can be used to turn the vehicle off. If a collision is detected, an additional emergency vehicle off display will be shown and can be pressed to turn the vehicle off. Refer to Section 3 for additional details.



Lifting Points

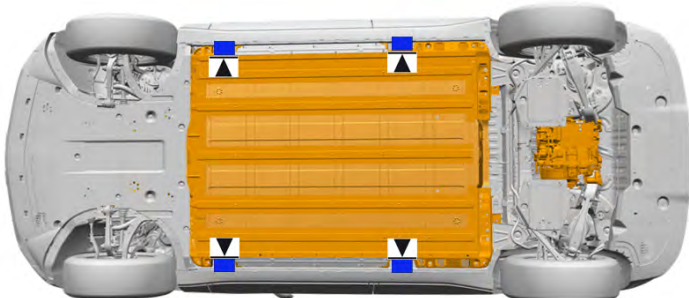

There are features on the body of the vehicle, for use as primary lifting points.

Do NOT lift the vehicle from any locations on the high voltage battery.

3. Disable direct hazards / safety regulations

Thermal Runaway Alert and Mitigation



The vehicle is equipped with a 12v battery management system with internal fault detection, including thermal runaway alert and mitigation for the high voltage battery.

To keep thermal runaway alert and mitigation available, **DO NOT** disable the 12v battery.

Automatic safety systems are enabled when low voltage power is available.

12v power is required for the high voltage battery management system to operate. The system is designed to detect internal faults and, if necessary, activate thermal runaway mitigation. A “Battery Danger Detected, Safely Exit Vehicle” notification may be displayed on the instrument panel with additional information, an OnStar call may be attempted to be placed and the horn, chime, and hazard lights may activate. OnStar advisors are trained to contact first responders.

DO NOT disable the 12v battery to disable the horn.



Hands-Free Start

Powering Off

When the drive cycle has been completed and the vehicle is shifted to P (Park), the vehicle will turn off once the seat belt is unbuckled, and the door is opened for driver’s exit.

The vehicle can also be turned off by pressing the “Vehicle Off” symbol on the infotainment display.

If the vehicle has not been shifted out of P (Park), it will not turn off based on driver exit detection and will need to be turned off by pressing the “Vehicle Off” symbol or waiting for the automatic shutdown timeout.

If a collision is detected, an additional emergency vehicle off icon will appear on the display and can be pressed to turn the vehicle off.



The high voltage system can remain energized even when the vehicle is in the OFF state.



Hood Release

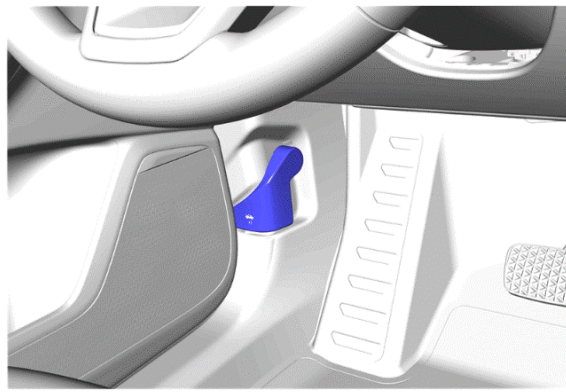

1. Pull the hood release handle on the lower left side of the instrument panel.
2. Release the handle, then pull the handle again to fully open the hood.
3. Go to the front of the vehicle and lift the hood open.



First Responder Loop Access

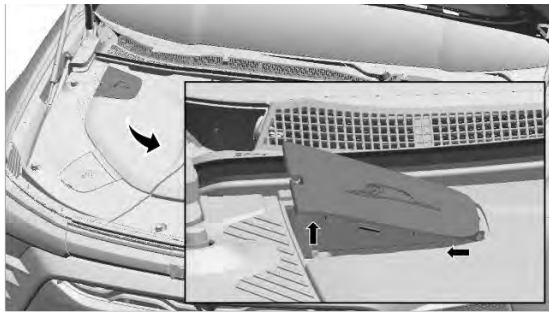

Remove the first responder loop access cover (if equipped):

1. Press on the outboard tab of the cover to release the outboard tab.
2. Rotate the cover up and pull the cover outboard to release the inboard tabs.

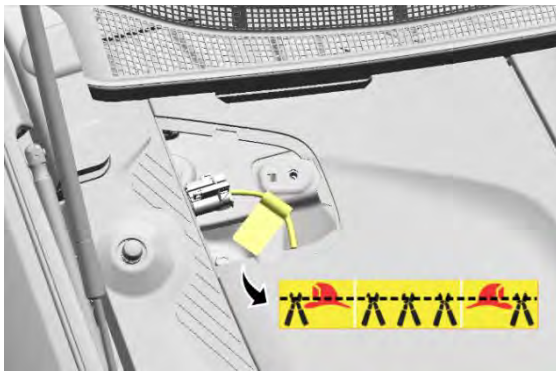

First Responder Loop

Double cut the first responder loop on both sides of the yellow tape and remove the cut section of cable from the vehicle. Ensure that the cuts are clean and that there is no risk of loose wires touching.

This cut will disable high voltage.

Airbags can be disabled by removing the 12v battery negative cable. This will disable the thermal runaway alert and mitigation. Consider any manipulations of power devices in the vehicle (steering wheel, power seats, windows, etc.) prior to disabling the 12v battery.

DO NOT CUT ANY ORANGE COLORED HIGH VOLTAGE CABLES.



After disabling the first responder cut loop, wait at least 1 minute to allow high voltage energy to discharge.

VEHICLE AT CHARGE STATION:

If able, terminate charging by removing the charge handle from the vehicle. If enabled, the vehicle's anti-theft alarm may activate. If the charge handle will not release, a manual release loop is located underhood, near the battery.

The common charge handle is shown; Actual charger / vehicle charge inlet may change based on model year and region.

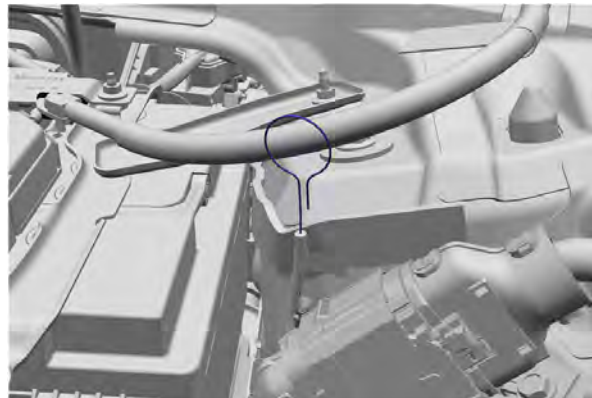

4. Access to the occupants

Refer to the vehicle *Rescue Sheet* for additional illustrations that show the locations of High Strength Structural Components, High Voltage Components, and Safety Components.

Vehicle Glass



The windshield is made of Laminated Glass.



The door windows, rear quarter windows, liftgate window and sunroof are made of Tempered Glass.



Opening a Locked Door

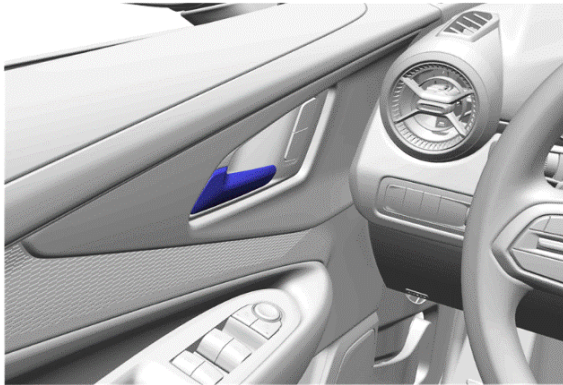

If the doors remain locked, pull **twice** on the inside door handle to gain access to the occupant at each seating location.

NOTE: An alternative method for rear passenger access may be necessary if the rear door child safety locks are engaged.

Steering Column Tilt and Telescoping Control Switch



1. Rotate the lever down to unlock the steering column.
2. The steering column can be moved up/down or in/out.
3. Rotate the lever up to lock the steering column in place.

Seat Controls - Manual

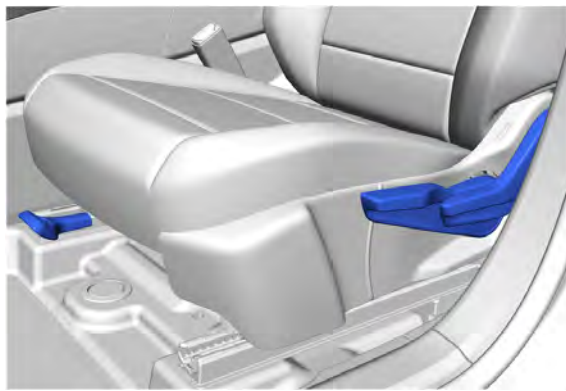

The seat handles function the same for the driver and front seat passenger.

Front Handle

Pull the handle forward and then slide the seat forward or rearward.

Middle Handle

Move the handle up or down to manually raise or lower the seat.

Rear Handle

Rotate the handle up to recline or raise the seatback.

Seat Controls - Power

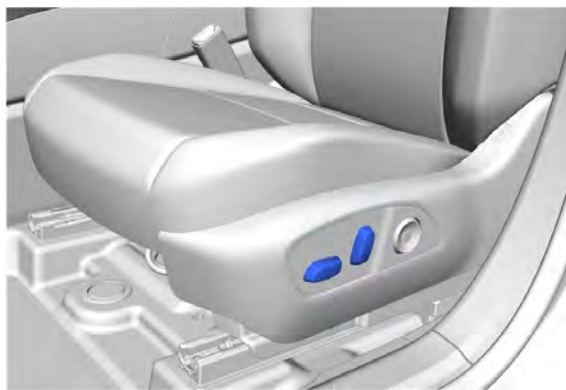

The seat switches function the same for the driver and front seat passenger.

Front Switch

- Move the seat forward or rearward by sliding the control forward or rearward.
- Raise or lower the seat by moving the control up or down.

Middle Switch

Rotate the switch forward to raise the seatback and rearward to recline the seatback.

Occupant Restraint Systems

The Blazer EV is equipped with eight airbags:

- Driver (Steering Wheel)
- Front Seat Passenger (Instrument Panel)
- (2) Front Knee Bolster Airbags
- (2) Front Seat Outboard Airbags
- (2) Roof Rail Airbags

There are seat belt restraints for five occupants.

The front seat belt system includes two pre-tensioners on each side. One is seat belt retractor mounted and the other is mounted to the seat belt anchor at the base of the seat. The rear outboard seats each have one pre-tensioner that is seat belt retractor mounted.

The rear seat includes child seat anchor points:

- Top tether anchors behind the seatback.
- Lower anchors at the base of the seatback.

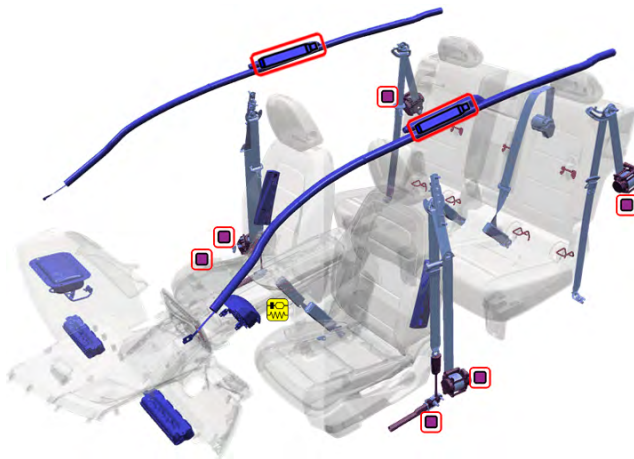

High Strength Steel Structure

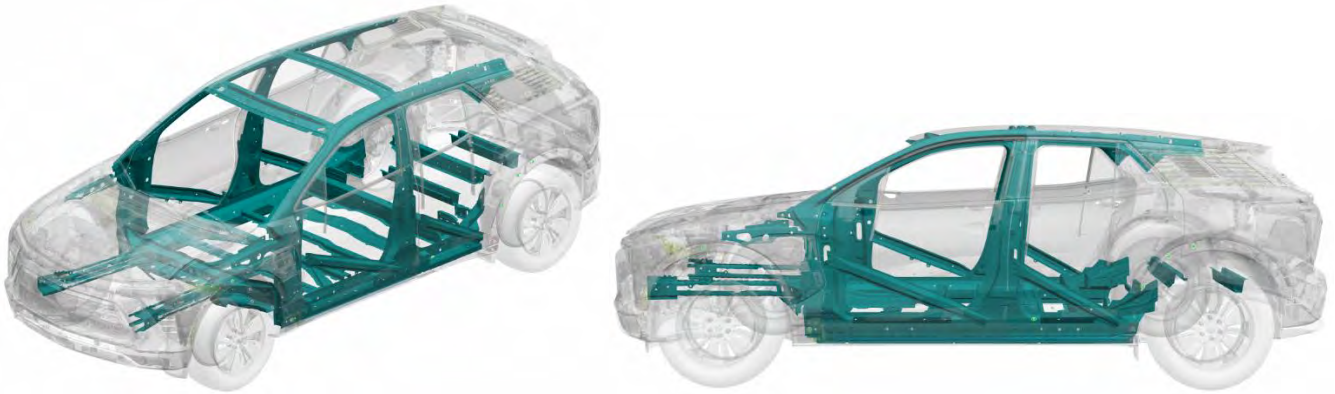





The passenger compartment is protected using high strength steel in the pillars, rocker panels, door reinforcement beams, and floor structure.











As with any occupant extrication, exercise caution. The vehicle's high voltage cables and components may be energized with high voltage. Avoid touching or cutting high voltage cables or components during any rescue operation.

5. Stored energy / liquids / gases / solids

12V Lead Acid	Low Voltage Lead Acid Chemistry Battery
400V Li-ion	High Voltage Lithium-Ion Chemistry Battery
	High Voltage Warning, potential for electric shock
	Gases emitted from the battery pack are flammable
	Gases emitted from the battery pack are toxic
	Skin contact may cause irritation. Prolonged contact with electrolyte mixture may result in more severe irritation. Flush contaminated skin with plenty of water.



Fluids leaking inside the battery pack can become unstable and possibly a risk for fire. Check the battery pack temperature with a thermal imaging camera.

6. In case of fire	
	High Voltage Warning, potential for electric shock
	A battery on fire will not explode
	A battery on fire will not explode. If battery cells reach high enough temperature, they vent and release electrolyte. Battery electrolyte is flammable.
	Gases emitted from the battery pack are toxic
	Skin contact may cause irritation. Prolonged contact with electrolyte mixture may result in more severe irritation. Flush contaminated skin with plenty of water.
	Potential for eye, nose, and throat irritation with prolonged exposure.
	Always wear Self-Contained Breathing Apparatus (SCBA). Use copious amounts of water to cool the battery and to extinguish a fire. Do NOT use an ABC dry chemical extinguisher because it will not extinguish a battery fire.
 	Potential for Battery Re-Ignition.

7. In case of submersion	
<p>The high voltage battery is isolated from the vehicle chassis. If the vehicle is immersed in water, there is no risk of electrocution by touching the vehicle.</p> <p>After the vehicle was removed from the water, do the following:</p> <ol style="list-style-type: none"> 1. Allow the vehicle to dry out. 2. Perform the high voltage disabling procedure in Section 3. 	

8. Towing / transportation / storage

Tow Hooks

Carefully open the cover in the fascia by using the small notch that conceals the tow eye socket.

Install the tow eye into the socket and turn it until it is fully tightened. When the tow eye is removed, reinstall the cover with the notch in the original position.

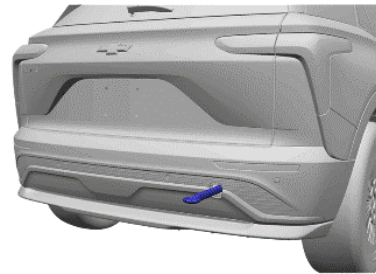
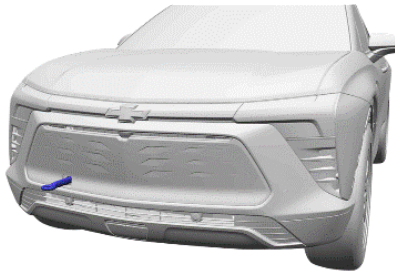

Vehicle Towing and Transportation

General Motors recommends a flatbed carrier to transport a disabled vehicle. A wheel lift truck along with properly rated tow dollies can be used if a flatbed carrier is not available.

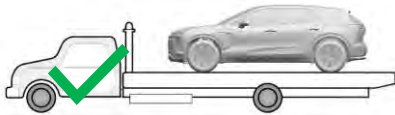

Moving the vehicle with the drive wheels on the ground will generate unwanted energy. Limit the movement of the vehicle to the distance required to prepare the vehicle for towing.



Potential for continued hazards (rekindling/re-gassing/etc) if a damaged vehicle battery is jostled during recovery, including the towing and storage process.



After a "Battery Damaged Detected, Safely Exit Vehicle" notification or thermal runaway mitigation cycle completed, it might be appropriate to wait up to an hour before towing to a certified dealer for vehicle inspection even though evidence of a thermal event such as smoke may not be visible, and unusual odors may not be detected from the vehicle. To disable the horn to tow the vehicle, remove the horn fuse.

Horn Fuse Removal



If the horn must be disabled prior to transport, locate and remove the horn fuse from the underhood electrical center.

Post-Crash Vehicle Storage

Store the vehicle outside at a safe distance (15 meters / 50 feet) or separated from flammable objects.

Disposal













The high voltage battery and leaked battery fluids should be properly disposed of according to local regulations. General Motors recommends removing and recycling the battery. Refer to recyclemybattery.com for more information on storing, disabling, removing, and shipping the battery along with a list of available recycling facilities.

9. Important additional information

This vehicle is supported by OnStar, where available.

This vehicle does NOT have a power button. The vehicle will turn off when shifted to P (Park), the seat belt is unbuckled, and the door is opened for driver's exit. The "Vehicle Off" or "Emergency Vehicle Off" symbols will appear on the Infotainment Display and can be used to turn the vehicle off. The "Emergency Vehicle Off" symbol will only appear when a collision is detected.

10. Explanation of pictograms used

	Electric Vehicle		General warning sign		Warning, Electricity
	Battery Technology		Lifting Points		Thermal Imaging Camera
	Flammable		Toxic		Corrosive
	Injury Risk		Use Water		Front Compartment Release
	Cable Cut Location				