

CHEVROLET BLAZER EV
5 Door Hatchback
2024 -

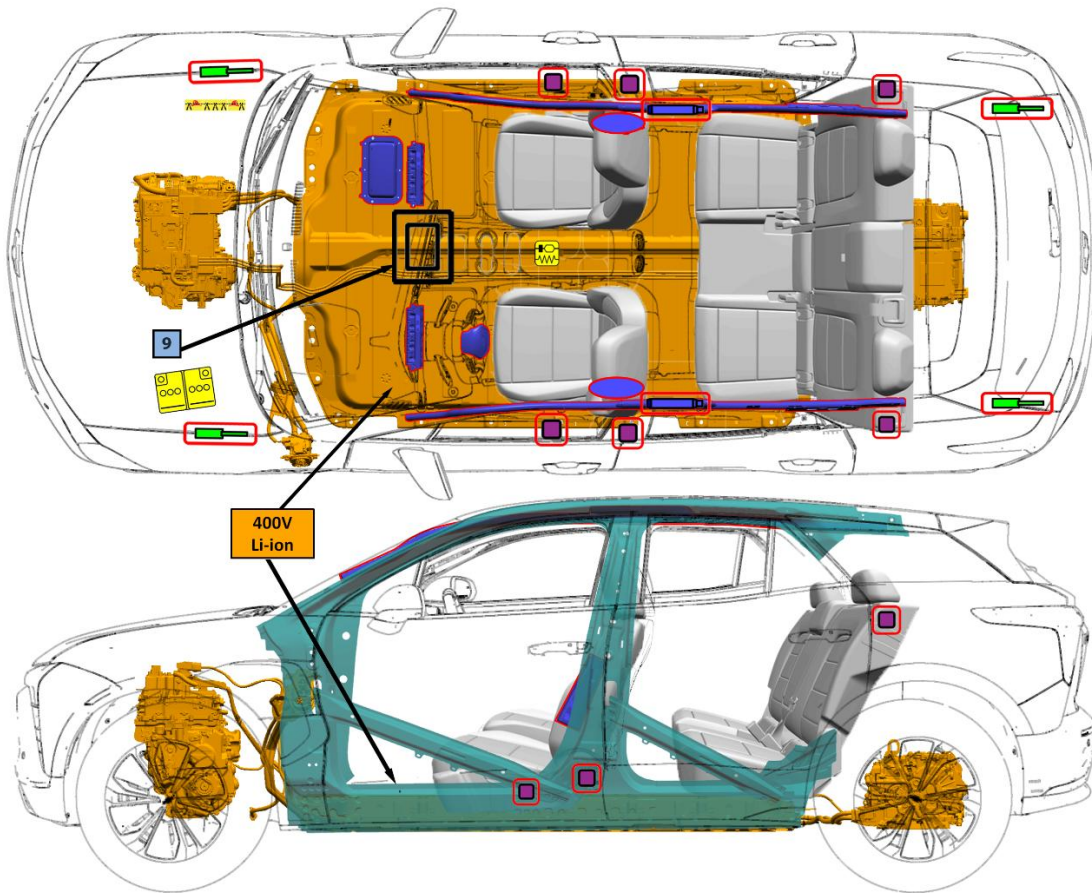

	Airbag		Stored gas inflator		Seat belt pretensioner		SRS control unit		Gas strut/ Preloaded spring
	High strength zone		Zone requiring special attention		Battery low voltage		High voltage battery pack		High voltage power cable component
	Cable Cut Location								

1. Identification / recognition



Lack of engine noise does not mean vehicle is off: vehicle movement capability exists until vehicle is fully shut down. Always wear appropriate PPE.

Emblems and Badging



First Responder Information Label

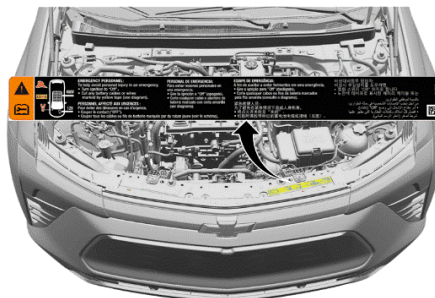

2. Immobilization / stabilization / lifting

IMMOBILIZE VEHICLE:

1. Block the wheels.
2. Press the Electric Parking Brake (EPB) switch momentarily. The red parking brake status light will flash and then stay on once the EPB is fully applied.
3. Press the button at the end of the shift lever to shift to P (Park).

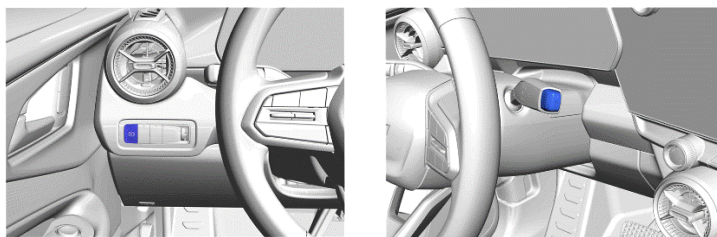

LIFTING POINTS:

-  There are features on the body of the vehicle, for use as primary lifting points. Do NOT lift the vehicle from any locations on the high voltage battery.



3. Disable direct hazards / safety regulations



The vehicle is equipped with a 12v battery management system with internal fault detection, including thermal runaway alert and mitigation. To keep thermal runaway alert and mitigation available, DO NOT disable the 12v battery. To disable high voltage, cut the first responder cut loop.

In the event of a "Battery Danger Detected, Safely Exit Vehicle" notification, DO NOT disable the 12v battery to disable the horn.

MAIN METHOD:

1. Power the vehicle off:
 - When the drive cycle is complete and the vehicle is shifted to P (Park), the seat belt is unbuckled, and the door is opened for driver's exit.
 - The vehicle can be turned off by pressing the "Vehicle Off" symbol on the infotainment display. If a collision is detected an additional emergency vehicle off icon will appear on the display and can be pressed to turn the vehicle off.
2. Consider any manipulations of power devices in the vehicle (steering wheel, power seats, windows, etc.) **prior to** disabling the 12v battery.
3. Open the hood. Pull the release handle two times successively.

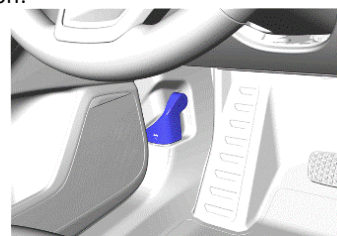

4. Remove the front compartment sight shield (if equipped).
5. Double cut the first responder loop on both sides of the yellow tape. Ensure that the cuts are clean and that there is no risk of loose wires touching.
6. Remove the cut section of cable from the vehicle.

Airbags can be disabled by removing the 12v battery negative cable. This will disable the thermal runaway alert and mitigation.

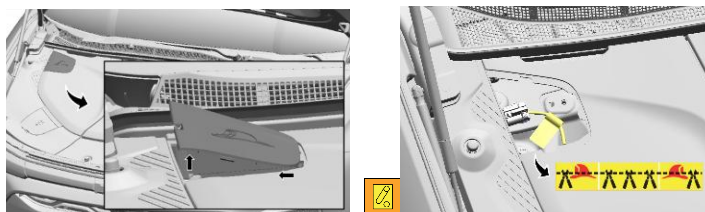

After disabling the first responder cut loop, wait at least 1 minute to allow high voltage energy to discharge.

VEHICLE AT CHARGE STATION:

If able, terminate charging by removing the charge handle from the vehicle. If enabled, the vehicle's anti-theft alarm may activate. If the charge handle will not release, a manual release loop is located underhood, near the battery.

The common charge handle is shown; Actual charger / vehicle charge inlet may change based on model year and region.

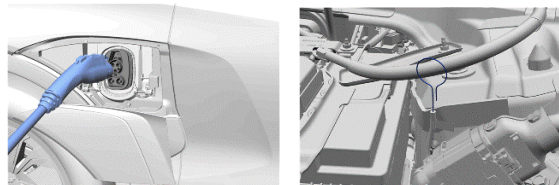

4. Access to the occupants

Refer to the front page for illustrations of high strength zones and specific safety related component locations.



The windshield is made of Laminated Glass.



The front and rear door windows, rear quarter windows, liftgate window and sunroof are made of Tempered Glass.

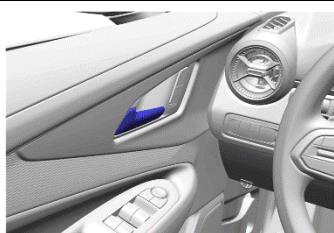
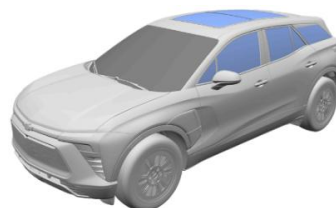

If the doors remain locked, pull **twice** on the inside door handle to gain access to the occupant at each seating location.

NOTE: An alternative method for rear passenger access may be necessary if the rear door child safety locks are engaged.

Steering Column Control

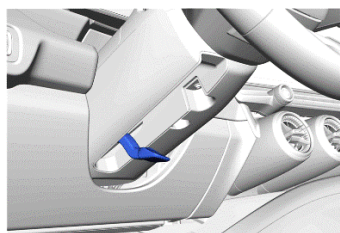

Seat Controls

Manual



Power

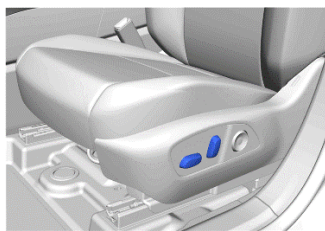

Rear Seat Child Seat Anchor Points



5. Stored energy / liquids / gases / solids



12V Lead Acid



400V Li-ion



Fluid leaking inside the battery pack can become unstable and possibly a risk for fire. Check the battery pack temperature with a thermal imaging camera.

6. In case of fire



A battery on fire will not explode.



Always wear Self-Contained Breathing Apparatus (SCBA).
Use copious amounts of water to cool the battery and to extinguish a fire.



Potential for Battery Re-Ignition.

7. In case of submersion

The high voltage battery is isolated from the vehicle chassis. If the vehicle is immersed in water, you will not be electrocuted by touching the vehicle.

After the vehicle was removed from the water, do the following:

1. Allow the vehicle to dry out.
2. Perform the high voltage disabling procedure in Section 3.

8. Towing / transportation / storage

Towing and Transportation

Carefully open the cover in the fascia by using the small notch that conceals the tow eye socket.

Install the tow eye into the socket and turn it until it is fully tightened. When the tow eye is removed, reinstall the cover with the notch in the original position.

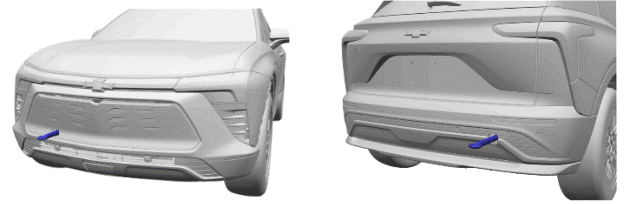

General Motors recommends a flatbed carrier to transport a disabled vehicle. A wheel lift truck along with properly rated tow dollies can be used if a flatbed carrier is not available.

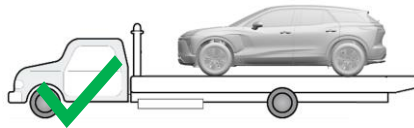

Moving the vehicle with the drive wheels on the ground will generate unwanted energy. Limit the movement of the vehicle to the distance required to prepare the vehicle for towing.

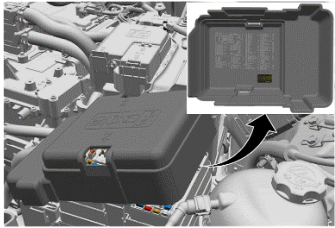

If the horn must be disabled prior to transport, locate and remove the horn fuse from the underhood electrical center.

Storage and Disposal

Store the vehicle outside at a safe distance (15 meters / 50 feet) or separated from flammable objects.

The high voltage battery and leaked battery fluids should be properly disposed of according to local regulations. General Motors recommends removing and recycling the battery. Refer to recyclemybattery.com for more information.



Potential for continued hazards (rekindling/re-gassing/etc) if a damaged vehicle battery is jostled during recovery, including the towing and storage process.

9. Important additional information

This vehicle is supported by OnStar, where available.

This vehicle does NOT have a power button. The vehicle will turn off when shifted to P (Park), the seat belt is unbuckled, and the door is opened for driver's exit. The "Vehicle Off" or "Emergency Vehicle Off" symbols will appear on the Infotainment Display and can be used to turn the vehicle off. The "Emergency Vehicle Off" symbol will only appear when a collision is detected.

10. Explanation of pictograms used

	Electric Vehicle		General warning sign		Warning, Electricity
	Battery Technology		Lifting Points		Thermal Imaging Camera
	Flammable		Toxic		Corrosive
	Injury Risk		Use Water		Cable Cut Location