

INFORMATION FOR FIRST AND SECOND RESPONDERS
EMERGENCY RESPONSE GUIDE

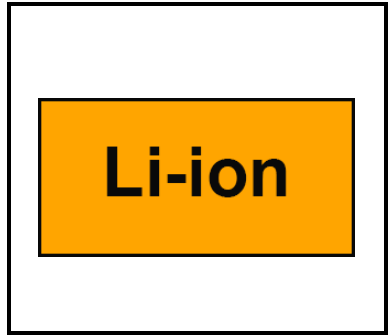

GMC HUMMER EV
Truck / SUV
Li-ion Battery









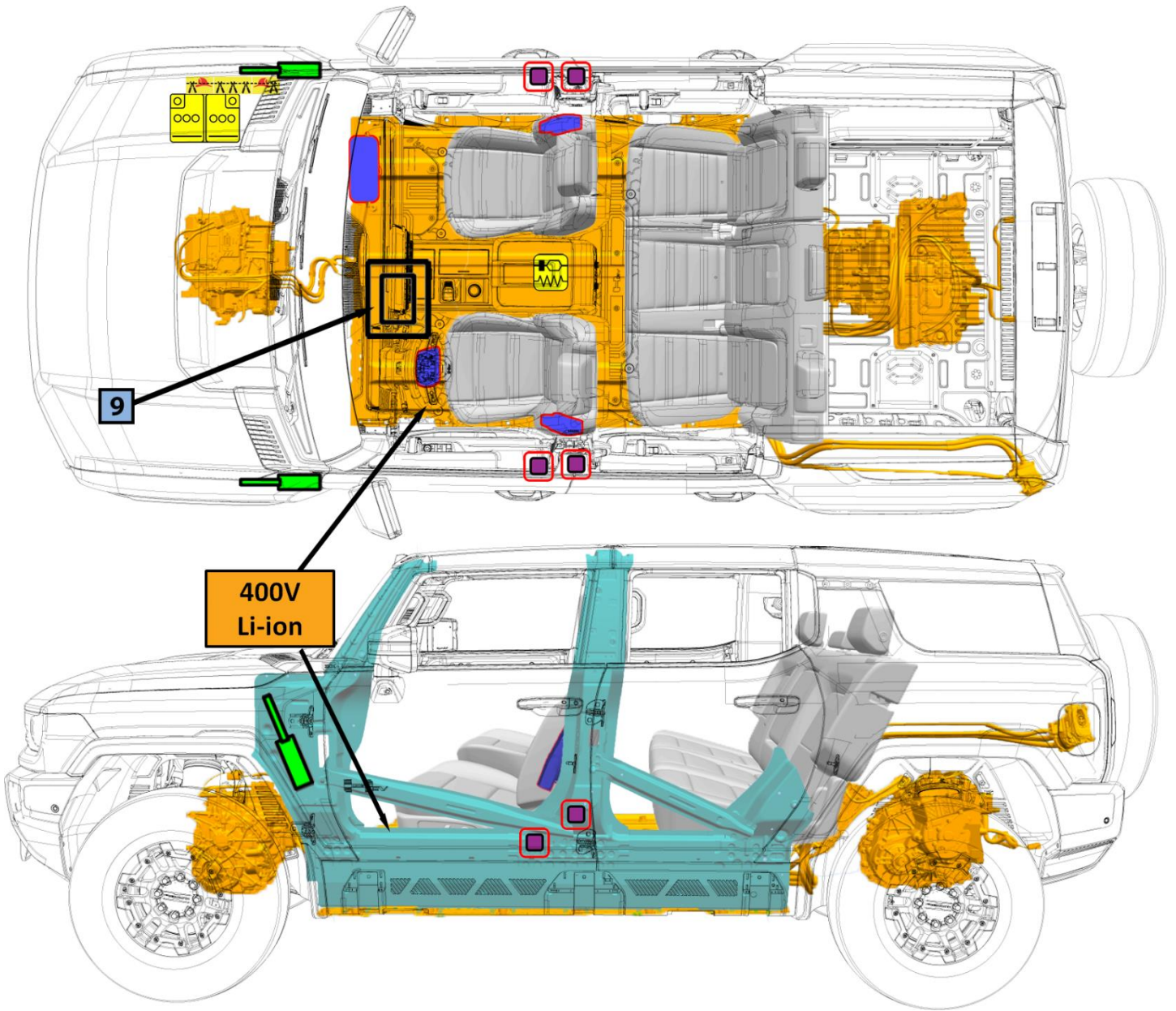



CONTENTS

0. Rescue Sheet	Page	3
1. Identification / recognition	Page	4
2. Immobilization / stabilization / lifting	Page	5
3. Disable direct hazards / safety regulations	Page	6
4. Access to the occupants	Page	8
5. Stored energy / liquids / gases / solids	Page	11
6. In case of fire	Page	11
7. In case of submersion	Page	12
8. Towing / transportation / storage	Page	12
9. Important additional information	Page	13
10. Explanation of pictograms used	Page	13

0. Rescue Sheet



	Airbag		Stored gas inflator		Seat belt pretensioner		SRS control unit		Gas strut/ Preloaded spring
	High strength zone		Zone requiring special attention		Battery low voltage		High voltage battery pack		High voltage power cable component
	Cable Cut Location								

1. Identification / recognition



Advise Dispatch and all responders that an electric vehicle is involved.



Lack of engine noise does not mean vehicle is off: vehicle movement capability exists until vehicle is fully shut down. Always wear appropriate PPE.

Emblems and Badging



In addition to the exterior images shown on the cover page, the HUMMER EV can be identified by badging that appears on many panels, including the:

- Lighted Front Grille Applique
- Tail Lamps
- Front Side Doors
- Exterior Mirrors
- Door Sills
- Steering Wheel



High Voltage Battery Information



The battery is a High Voltage (Class B) Li-ion pack, that is mounted under the vehicle and is a structural part of the floor pan.



Battery Warning Label

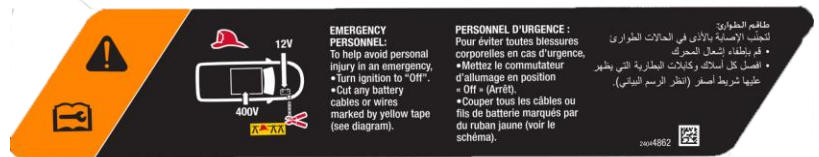
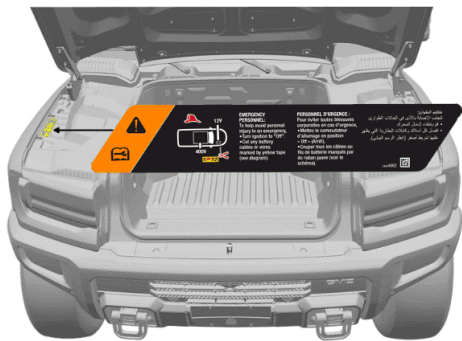

2. Immobilization / stabilization / lifting



IMMOBILIZE VEHICLE

- Block the wheels.
- Follow procedures for conventional vehicles.

Electric Parking Brake (EPB)

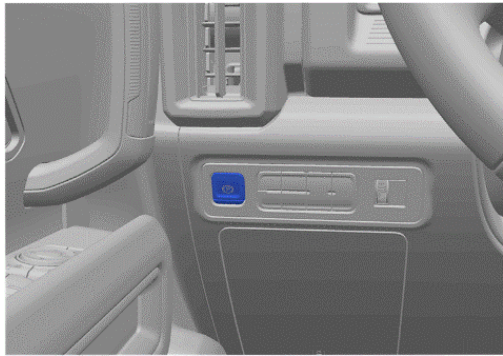

Applying the Electric Parking Brake

Press the EPB switch momentarily. The red parking brake status light will flash and then stay on once the EPB is fully applied.

Releasing the Electric Parking Brake

1. Turn the vehicle on.
2. Apply and hold the brake pedal.
3. Press the EPB switch momentarily.

The EPB is released when the red parking brake status light is off.

Electric Drive Unit Shift Lever

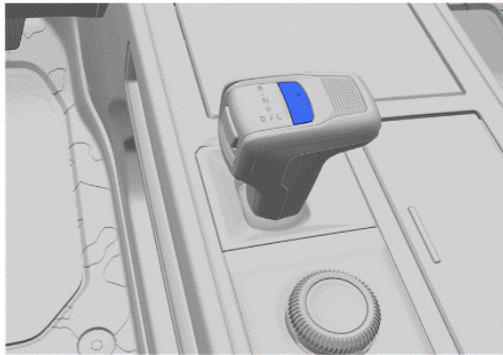

Shifting into Park

Press the button on top of the shift lever to shift to P (Park).



Power Button (2024-2025)

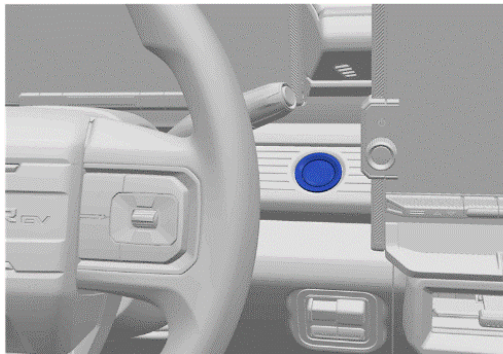

To turn the vehicle off, press the button on top of the shift lever to shift to P (Park) and press the POWER button.

Alternatively, press and hold the POWER button. The electric drive unit will shift to P (Park) then shut off automatically.



Hands-Free Start (2026 and Later)

This vehicle does NOT have a power button. The vehicle will turn off when shifted to P (Park), seat belt is unbuckled, and the door is opened for driver's exit.

A "Vehicle Off" symbol will appear on the infotainment display and can be used to turn the vehicle off. If a collision is detected, an additional emergency vehicle off display will be shown and can be pressed to turn the vehicle off. Refer to Section 3 for additional details.



Lifting Points

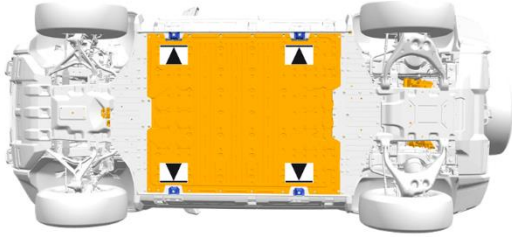

There are features on the body of the vehicle, for use as primary lifting points. Do NOT use these features as attachment points to move or tie the vehicle down.

Do NOT lift the vehicle from any locations on the high voltage battery.

3. Disable direct hazards / safety regulations

Thermal Runaway Alert and Mitigation



The vehicle is equipped with a 12v battery management system with internal fault detection, including thermal runaway alert and mitigation for the high voltage battery.

To keep thermal runaway alert and mitigation available, DO NOT disable the 12v battery.

Automatic safety systems are enabled when low voltage power is available.

12v power is required for the high voltage battery management system to operate. The system is designed to detect internal faults and, if necessary, activate thermal runaway mitigation. A “Battery Danger Detected, Safely Exit Vehicle” notification may be displayed on the instrument panel with additional information, an OnStar call may be attempted to be placed and the horn, chime, and hazard lights may activate. OnStar advisors are trained to contact first responders.

DO NOT disable the 12v battery to disable the horn.



Power Button

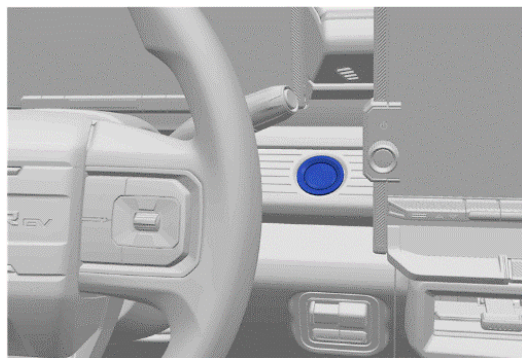

If the vehicle is already in PARK state, press the POWER button to disable vehicle propulsion.

Alternatively, press and hold the POWER button. The electric drive unit will shift to P (Park) then shut off automatically.



The high voltage system can remain energized even when the vehicle is in the OFF state.



Hands-Free Start (2026 and Later)

Powering Off

When the drive cycle has been completed and the vehicle is shifted to P (Park), the vehicle will turn off once the seat belt is unbuckled, and the door is opened for driver’s exit.

The vehicle can also be turned off by pressing the “Vehicle Off” symbol on the infotainment display.

If the vehicle has not been shifted out of P (Park), it will not turn off based on driver exit detection and will need to be turned off by pressing the “Vehicle Off” symbol or waiting for the automatic shutdown timeout.

If a collision is detected, an additional emergency vehicle off icon will appear on the display and can be pressed to turn the vehicle off.



The high voltage system can remain energized even when the vehicle is in the OFF state.



Inside Access to Hood Release

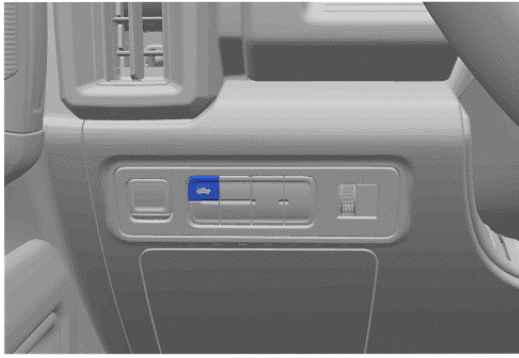

Power Operation

To open the hood, press the button on the instrument panel to the left of the steering wheel once.

To close the hood, press the button and hold until the hood closes.

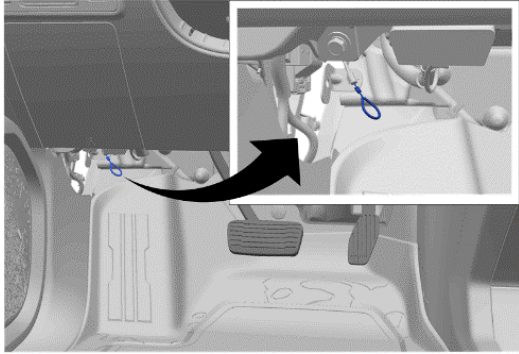

Manual Operation

The Manual Release Cable is located at the outboard side of the driver's footwell.

Firmly pull the hood release cable twice to release the hood. It is on the lower left side of the instrument panel.



Outside Access to Hood Release

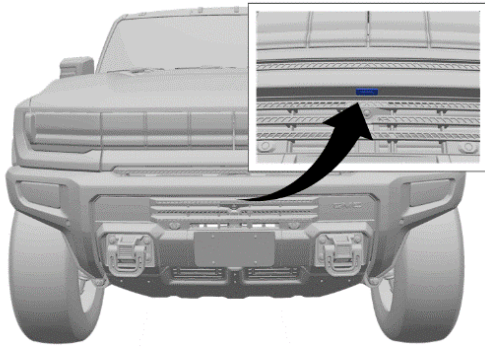

Power Operation

To open or close the hood, press the touch pad in the center of the front fascia once, when the RKE transmitters within 1 m (3 ft).

Manual Operation

Press and release the touch pad on the front fascia. Lift the hood to open.

To close the hood, pull the hood down until it is secured in the latch. When the hood is in the latch, the hood will automatically close.



First Responder Loop Access

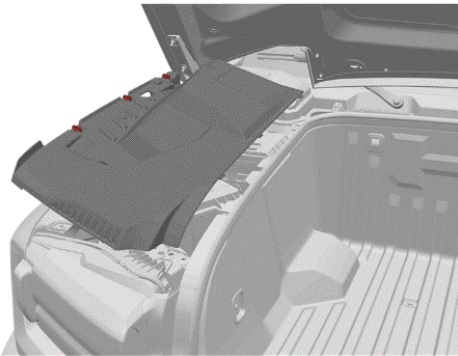

Front Compartment Sight Shield

1. Rotate the 3 quarter turn retainers on the sight shield.
2. Lift the outboard edge of the sight shield up and pull the panel out to remove.

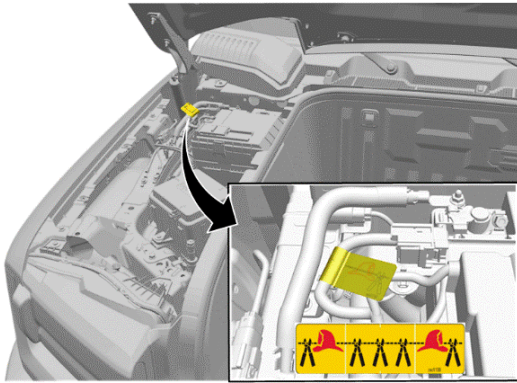

First Responder Loop

Double cut the first responder loop on both sides of the yellow tape and remove the cut section of cable from the vehicle. Ensure that the cuts are clean and that there is no risk of loose wires touching.

This cut will disable the high voltage.

Airbags can be disabled by removing the 12v battery negative cable. This will disable the thermal runaway alert and mitigation. Consider any manipulations of power devices in the vehicle (steering wheel, power seats, windows, etc.) prior to disabling the 12v battery.

DO NOT CUT ANY ORANGE COLORED HIGH VOLTAGE CABLES.



After disabling the first responder cut loop, wait at least 1 minute to allow high voltage energy to discharge.

VEHICLE AT CHARGE STATION:

If able, terminate charging by removing the charge handle from the vehicle. If enabled, the vehicle's anti-theft alarm may activate. If the charge handle will not release, a manual release loop is in the left side rear wheelhouse.

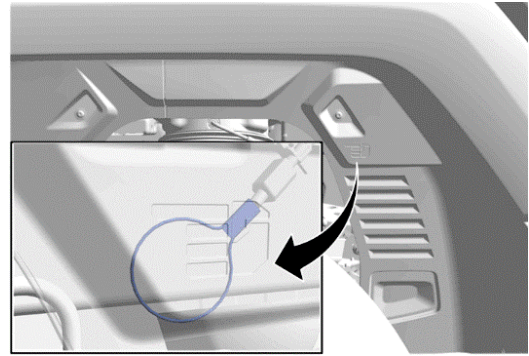

Common charge handle is shown; DC Fast Charge handle is moderately larger and may require additional effort to disconnect.



4. Access to the occupants

Refer to the vehicle *Rescue Sheet* for additional illustrations that show the locations of High Strength Structural Components, High Voltage Components, and Safety Components.

Vehicle Glass and Removable Roof Panels

-  - The windshield is made of Laminated Glass
-  - The door windows, rear quarter windows and rear window are made of Tempered Glass
-  - The removable roof panels are made of Polycarbonate Material

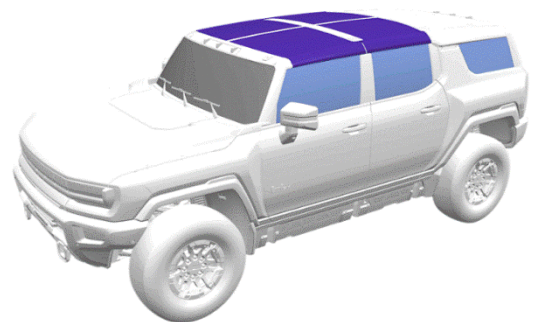

Opening a Locked Side Door

If the doors remain locked, pull **twice** on the inside door handle to gain access to the occupant at each seating location.

NOTE: An alternative method for rear passenger access may be necessary if the rear door child safety locks are engaged.

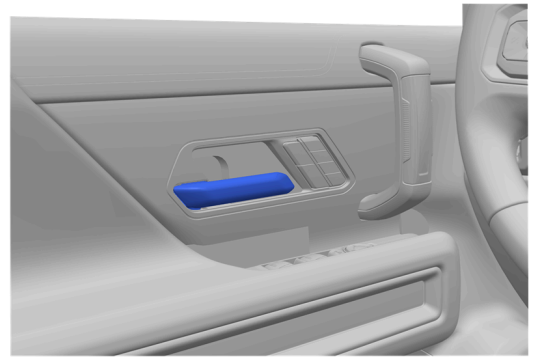

Outside Method to Open Rear Compartment Access Door



To open or close the swing gate, press the touch pad below the left hand taillamp.

Inside Method to Open to Rear Compartment Access Door

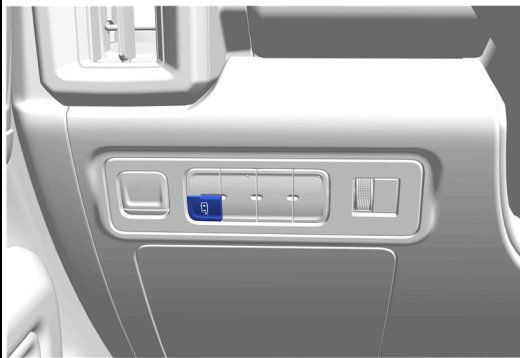

Power Operation

To open the swing gate, press the button on the instrument panel to the left of the steering wheel.

To close the swing gate, press the button and hold until the swing gate closes.

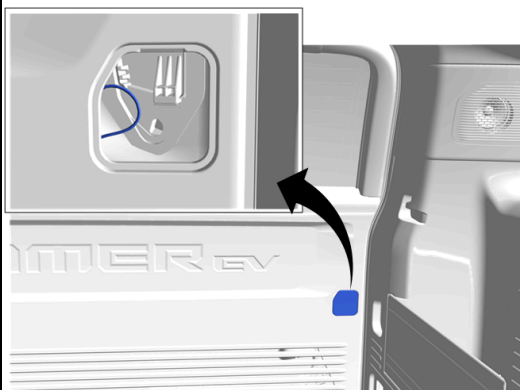

Manual Operation

The swing gate release cable is located on the left hand side of the swing gate behind the cable access cover.

Firmly pull the swing gate release cable to release the swing gate.

Steering Column Tilt and Telescoping Control Switch



- Press the control up or down to tilt the steering wheel up or down.
- Press the control rearward or forward to move the steering wheel closer or away from you.

Seat Control Switches

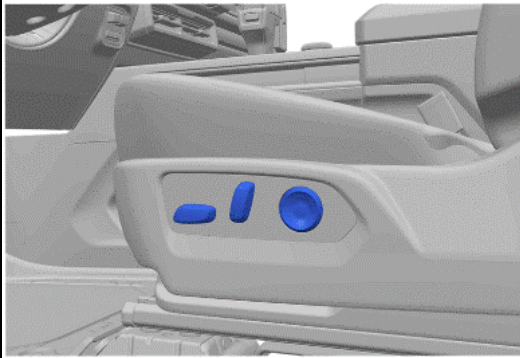

The seat switches function the same for the driver and front seat passenger.

Front Switch

- Move the seat forward or rearward by sliding the control forward or rearward.
- Raise or lower the seat by moving the control up or down.

Middle Switch

Rotate the switch forward to raise the seatback and rearward to recline the seatback.

Occupant Restraint Systems

The HUMMER EV is equipped with four Airbags:

- Driver
- Front Seat Passenger
- (2) Front Seat Outboard Airbags

There are seat belt restraints for five occupants. The front seat belt system includes belt retractor mounted pre-tensioners.

The rear seats includes child seat anchor points:

- Top tether anchors behind the seatback
- Lower anchors at the base of the seatback.

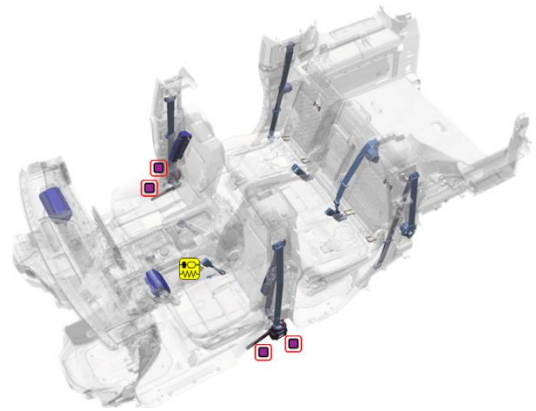



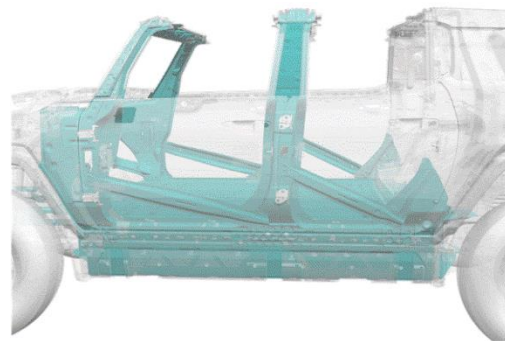
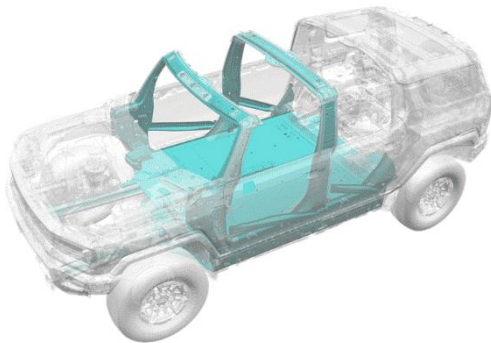



High Strength Steel Structure











The passenger compartment is protected using high strength steel in the pillars, rocker panels, door reinforcement beams, and floor structure.



As with any occupant extrication, exercise caution. The vehicle's high voltage cables and components may be energized with high voltage. Avoid touching or cutting high voltage cables or components during any rescue operation.

5. Stored energy / liquids / gases / solids	
12V Lead Acid	Low Voltage Lead Acid Chemistry Battery
400V Li-ion	High Voltage Lithium Ion Chemistry Battery
	High Voltage Warning, potential for electric shock
	Gases emitted from the battery pack are flammable
	Gases emitted from the battery pack are toxic
	Skin contact may cause irritation. Prolonged contact with electrolyte mixture may result in more severe irritation. Flush contaminated skin with plenty of water.
  Fluids leaking inside the battery pack can become unstable and possibly a risk for fire. Check the battery pack temperature with a thermal imaging camera.	

6. In case of fire	
	High Voltage Warning, potential for electric shock
	A battery on fire will not explode
	A battery on fire will not explode. If battery cells reach high enough temperature, they vent and release electrolyte. Battery electrolyte is flammable.
	Gases emitted from the battery pack are toxic
	Skin contact may cause irritation. Prolonged contact with electrolyte mixture may result in more severe irritation. Flush contaminated skin with plenty of water.
	Potential for eye, nose, and throat irritation with prolonged exposure.
	Use copious amounts of water to cool the battery and to extinguish a fire. Do NOT use an ABC dry chemical extinguisher because it will not extinguish a battery fire.
  Potential for Battery Re-Ignition.	

7. In case of submersion

The high voltage battery is isolated from the vehicle chassis. If the vehicle is immersed in water, you will not be electrocuted by touching the vehicle.

After the vehicle was removed from the water, do the following:

1. Allow the vehicle to dry out.
2. Perform the high voltage disabling procedure in Section 3.

8. Towing / transportation / storage

Tow Hooks

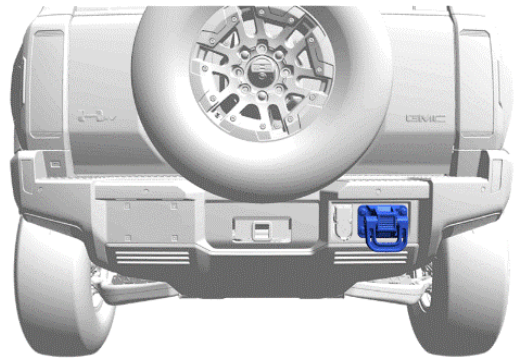

The vehicle is equipped with two front tow hooks used to pull the vehicle onto a flatbed carrier from a flat road surface.

The vehicle may be equipped with an optional rear tow hook to pull the vehicle onto a flatbed carrier from a flat road surface.

Vehicle Towing and Transportation

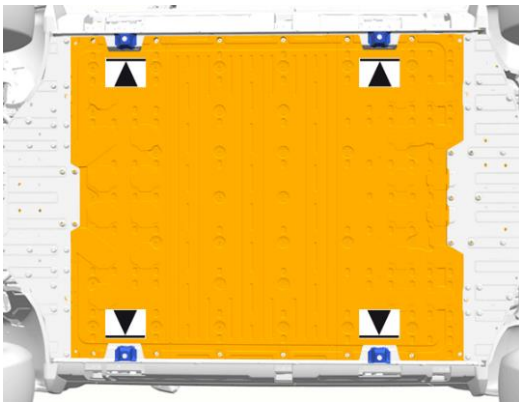

The lifting point features should only be used for lifting the vehicle. Do NOT use these features as attachment points to move or tie the vehicle down.

General Motors recommends a flatbed carrier to transport a disabled vehicle. A wheel lift truck along with properly rated tow dollies can be used if a flatbed carrier is not available.



General Motors recommends a flatbed carrier to transport a disabled vehicle.

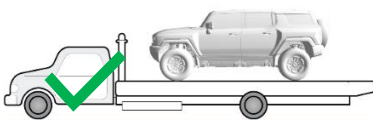

Moving the vehicle with the drive wheels on the ground will generate unwanted energy. Limit the movement of the vehicle to the distance required to load the vehicle onto a flatbed carrier.



Potential for continued hazards (rekindling/re-gassing/etc) if a damaged vehicle battery is jostled during recovery, including the towing and storage process.



After a "Battery Damaged Detected, Safely Exit Vehicle" notification or thermal runaway mitigation cycle completed, it might be appropriate to wait up to an hour before towing to a certified dealer for vehicle inspection even though evidence of a thermal event such as smoke may not be visible, and unusual odors may not be detected from the vehicle. To disable the horn to tow the vehicle, remove the horn fuse.

Horn Fuse Removal

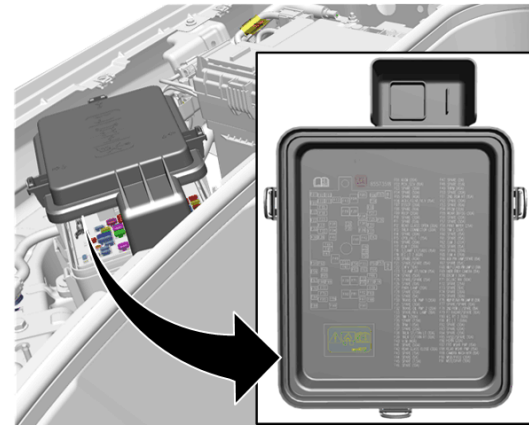

If the horn must be disabled prior to transport, locate and remove the horn fuse from the underhood electrical center.

Post-Crash Vehicle Storage

Store the vehicle outside at a safe distance (15 meters / 50 feet) or separated from flammable objects.

Disposal

The high voltage battery and leaked battery fluids should be properly disposed of according to local regulations. General Motors recommends removing and recycling the battery. Refer to recyclemybattery.com for more information on storing, disabling, removing, and shipping the battery along with a list of available recycling facilities.

9. Important additional information

This vehicle is supported by OnStar, where available.

(2026 and Later) This vehicle does NOT have a power button. The vehicle will turn off when shifted to P (Park), the seat belt is unbuckled, and the door is opened for driver's exit. The "Vehicle Off" or "Emergency Vehicle Off" symbols will appear on the Infotainment Display and can be used to turn the vehicle off. The "Emergency Vehicle Off" symbol will only appear when a collision is detected.

10. Explanation of pictograms used

	Electric Vehicle		General warning sign		Warning, Electricity
	Battery Technology		Lifting Points		Thermal Imaging Camera
	Flammable		Toxic		Corrosive
	Injury Risk		Use Water		Front Compartment Release
	Power Button		Cable Cut Location		