

**INFORMATION FOR FIRST AND SECOND RESPONDERS**  
**EMERGENCY RESPONSE GUIDE**

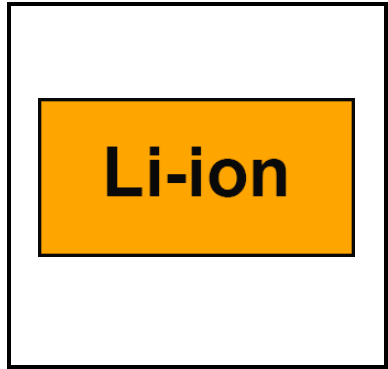

**Cadillac Escalade**  
**IQ/IQL**  
**5 Door SUV**  
**All Wheel Drive**



# CONTENTS

0. Rescue Sheet	Page	3
1. Identification / recognition	Page	4
2. Immobilization / stabilization / lifting	Page	5
3. Disable direct hazards / safety regulations	Page	6
4. Access to the occupants	Page	8
5. Stored energy / liquids / gases / solids	Page	11
6. In case of fire	Page	11
7. In case of submersion	Page	12
8. Towing / transportation / storage	Page	12
9. Important additional information	Page	14
10. Explanation of pictograms used	Page	14

# 0. Rescue Sheet

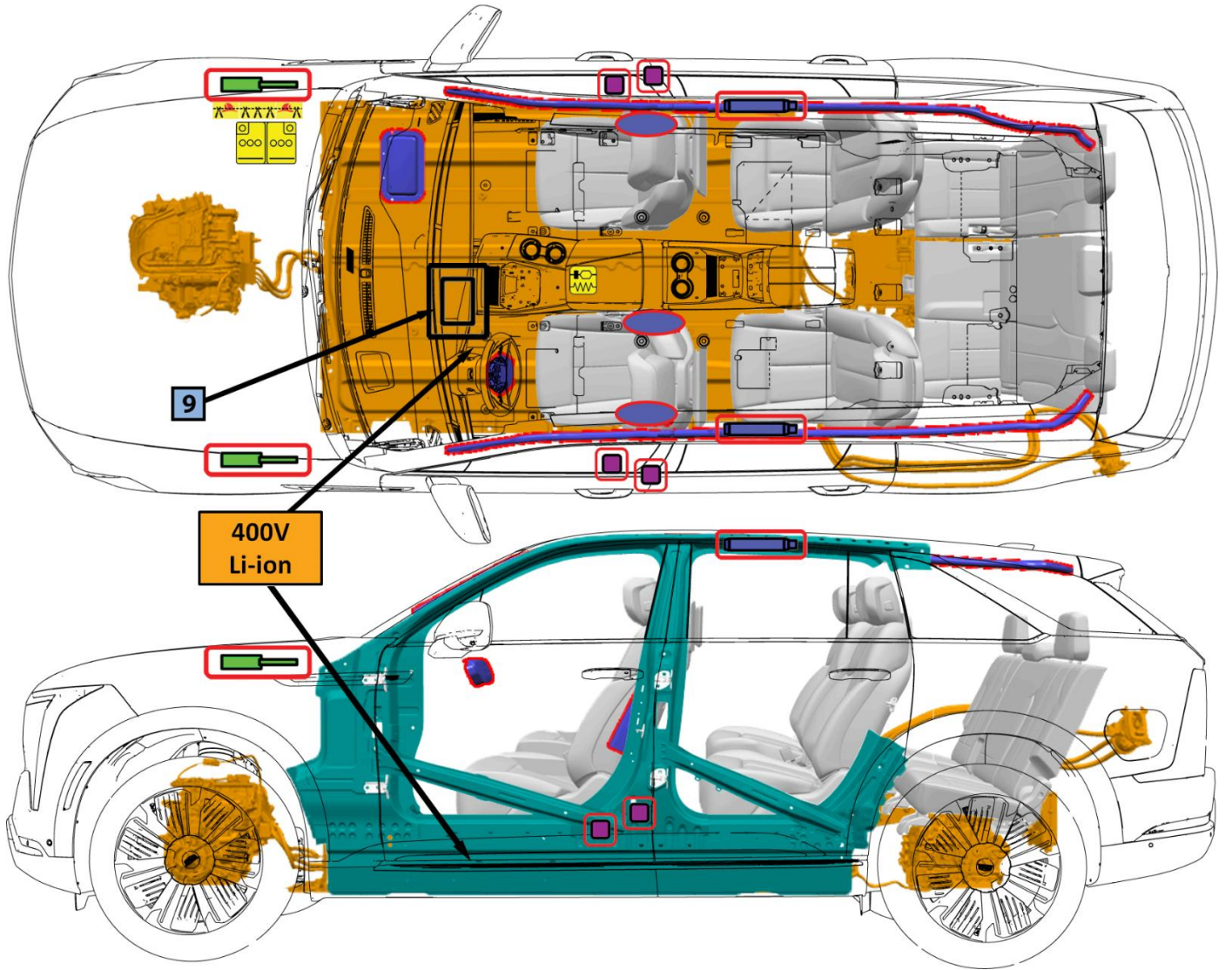

	Airbag		Stored gas inflator		Seat belt pretensioner		SRS control unit		Gas strut/ Preloaded spring
	High strength zone		Zone requiring special attention		Battery low voltage		High voltage battery pack		High voltage power cable component
	Cable Cut Location								

## 1. Identification / recognition



Advise Dispatch and all responders that an electric vehicle is involved.



Lack of engine noise does not mean vehicle is off: vehicle movement capability exists until vehicle is fully shut down. Always wear appropriate PPE.

### Emblems and Badging

ESCALADE  
IQ  
ESCALADE  
IQL

In addition to the exterior images shown on the cover page, the Cadillac Escalade IQ and IQL can be identified by the nameplate that appears on the liftgate.



### High Voltage Battery Information



The battery is a High Voltage (Class B) Li-ion pack, that is a mounted under the vehicle and is a structural part of the floor pan.



### Battery Warning Label

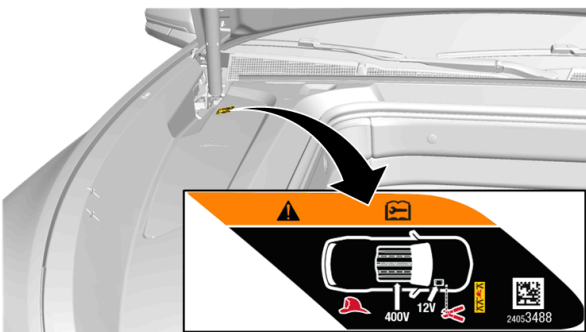

The battery warning label is located on the front compartment sight shield on the right side of the vehicle.

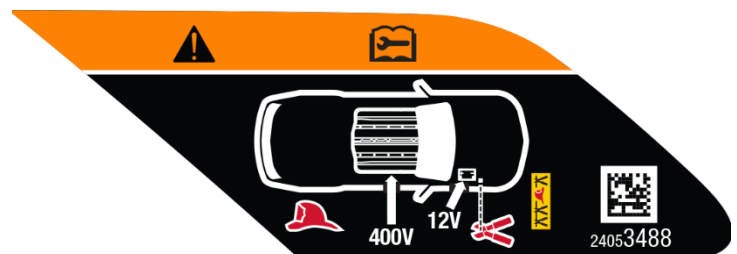

## 2. Immobilization / stabilization / lifting



### IMMOBILIZE VEHICLE

- Block the wheels.
- Follow procedures for conventional vehicles.

### Electric Parking Brake (EPB)

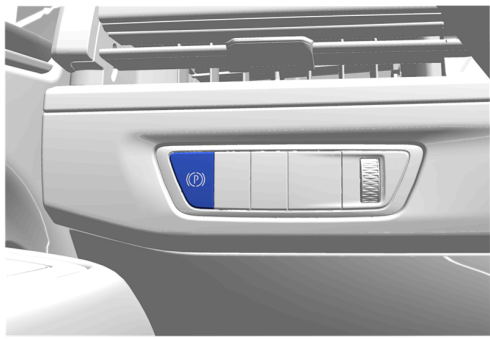

#### Applying the Electric Parking Brake

Press the EPB switch momentarily. The red parking brake status light will flash and then stay on once the EPB is fully applied.

#### Releasing the Electric Parking Brake

1. Turn the vehicle on.
2. Apply and hold the brake pedal.
3. Press the EPB switch momentarily.

The EPB is released when the red parking brake status light is off.

### Electric Drive Unit Shift Lever

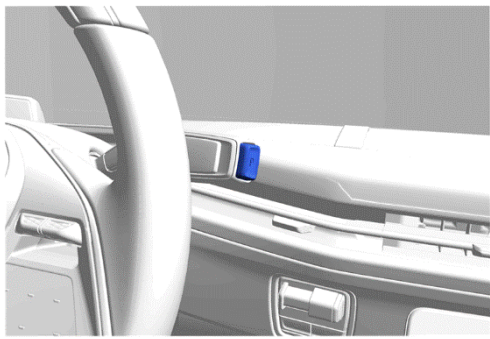

#### Shifting into Park

Press the button at the end of the shift lever to shift to P (Park).



### Passive Power Mode (Hands-Free Start)

This vehicle does NOT have a power button. The vehicle will turn off when shifted to P (Park) and a driver exit is detected.

The “Vehicle Off” symbol  will appear on the infotainment display and can be used to turn the vehicle off. If a collision is detected, an additional “Emergency Vehicle Off” symbol will appear on the display and can be pressed to turn the vehicle off. Refer to Section 3 for additional details.



### Lifting Points

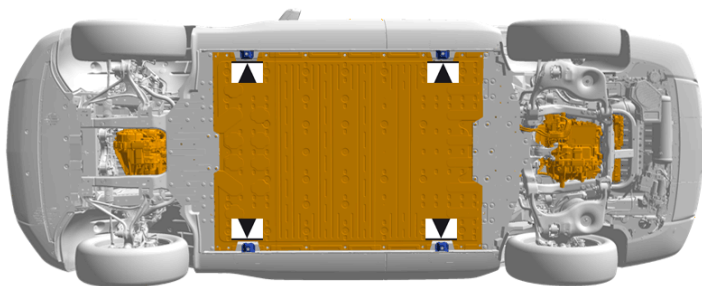

There are features on the body of the vehicle, for use as primary lifting points. Do NOT use these features as attachment points to move or tie the vehicle down.

Do NOT lift the vehicle from any locations on the high voltage battery.

### 3. Disable direct hazards / safety regulations

#### Thermal Runaway Mitigation



The vehicle is equipped with a battery management system with internal fault detection, including thermal runaway mitigation. In the event of a **“Battery Danger Detected”** notification, **DO NOT disable the 12v battery.**

Automatic safety systems are enabled when low voltage power is available.

When these safeguards are activated, OnStar Advisors will contact First Responders. Information about this feature will be displayed on the driver instrument panel including a “Battery Danger Detected” message. The vehicle will also activate the horn and the hazard lights.

In the event of a “Battery Danger Detected” notification, DO NOT disable the 12v battery during the thermal runaway mitigation cycle.



#### Passive Power Mode (Hands-Free Start)

##### Powering Off

When the drive cycle has been completed and the vehicle is shifted to P (Park), the vehicle will turn off when a driver exit is detected. The vehicle can also be turned off by pressing the “Vehicle Off” symbol on the infotainment display.

If the vehicle has not been shifted out of P (Park), it will not turn off based on driver exit detection and will need to be turned off by pressing the “Vehicle Off” symbol  or waiting for the automatic shutdown timeout.

If a collision is detected, an additional emergency vehicle off icon will appear on the display and can be pressed to turn the vehicle off.



The high voltage system can remain energized even when the vehicle is in the OFF state.



#### Inside Access to Hood Release

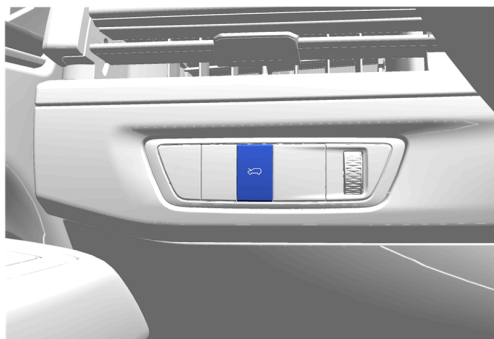

##### Power Operation

To open the hood, press the button on the instrument panel to the left of the steering wheel.

To close the hood, press the button and hold until the hood closes.

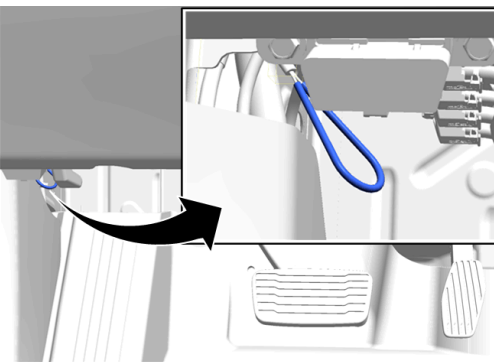

##### Manual Operation

The Manual Release Cable is located at the outboard side of the driver's footwell.

Firmly pull the hood release cable twice to release the hood. It is on the lower left side of the instrument panel.



## Outside Access to Hood Release

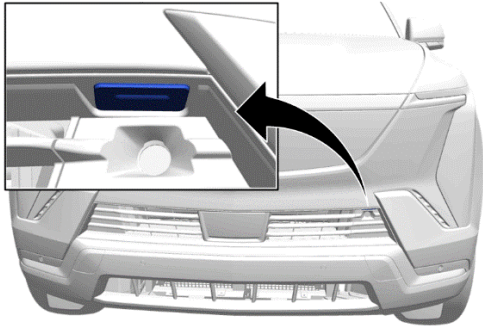

### Manual Operation

Press and release the touch pad in the grille area. Lift the hood to open. To close the hood, pull the hood down until it is secured in the latch. When the hood is in the latch, the hood will automatically close.

### Power Operation

To open or close the hood, press the touch pad in the center of the front fascia once, when the RKE transmitters within 1 m (3 ft).



## First Responder Loop Access

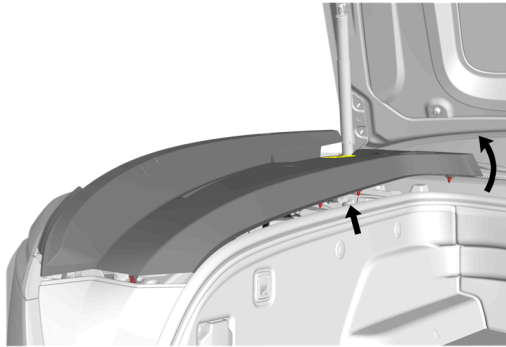

### Front Compartment Sight Shield

Starting at the rear edge of the sight shield, lift up and work forward to release the remaining retainers.

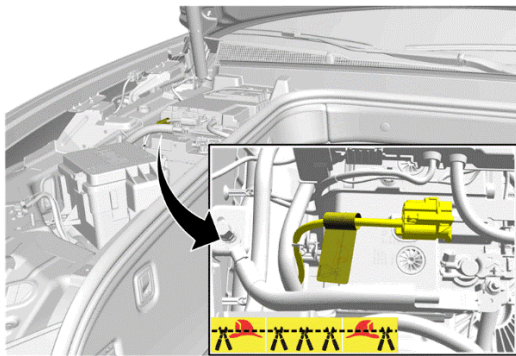

### First Responder Loop

Double cut the first responder loop on both sides of the yellow tape and remove the cut section of cable from the vehicle. Ensure that the cuts are clean and that there is no risk of loose wires touching.

This cut will disable the high voltage.

Airbags can be disabled by removing the 12v battery negative cable. DO NOT disable the 12v battery in the event of a "Battery Danger Detected" notification.

**DO NOT CUT ANY ORANGE COLORED HIGH VOLTAGE CABLES.**



After disabling the first responder cut loop, wait at least 1 minute to allow high voltage energy to discharge.

## VEHICLE AT CHARGE STATION:

If able, terminate charging by removing the charge handle from the vehicle. If enabled, the vehicle's anti-theft alarm may activate. If the charge handle will not release, a manual release loop is in the left side rear wheelhouse.

Common charge handle is shown; DC Fast Charge handle is moderately larger and may require additional effort to disconnect.

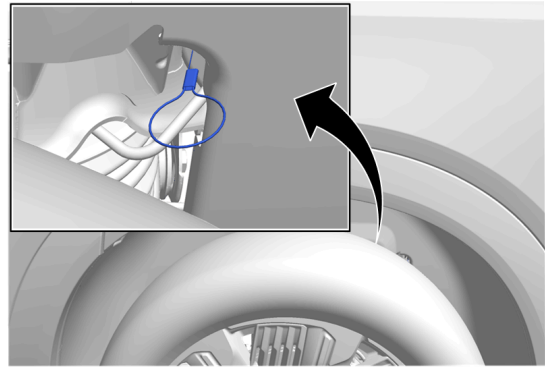
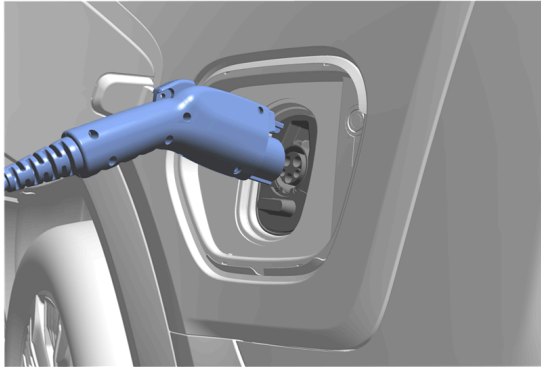

## 4. Access to the occupants

Refer to the vehicle *Rescue Sheet* for additional illustrations that show the locations of High Strength Structural Components, High Voltage Components, and Safety Components.

### Vehicle Glass

 - The windshield and sunroof are made of Laminated Glass

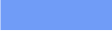
 - The door windows and rear window are made of Tempered Glass

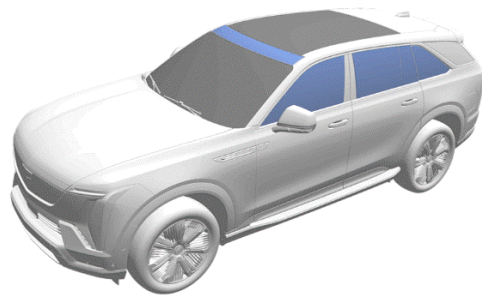

### Opening a Locked Side Door

If the doors remain locked, pull **twice** on the inside door handle to gain access to the occupant at each seating location.

**NOTE:** An alternative method for rear passenger access may be necessary if the rear door child safety locks are engaged.

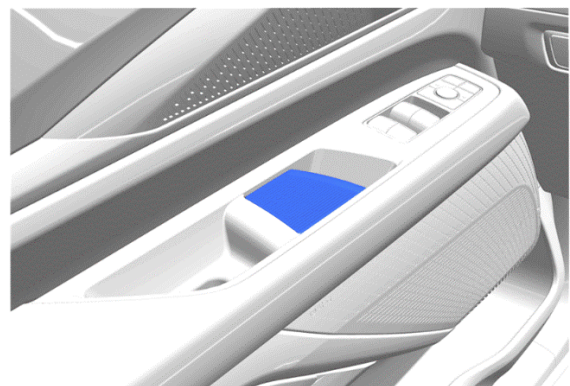



## Steering Column Tilt and Telescoping Control

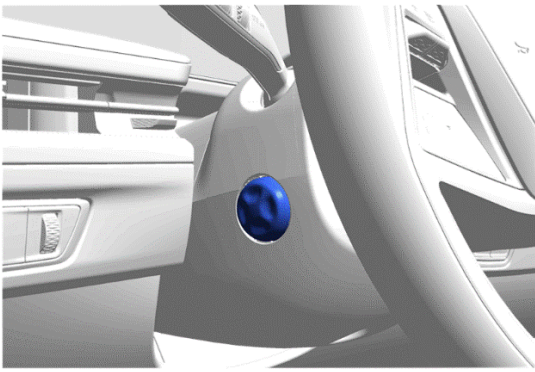

- Press the control up or down to tilt the steering wheel up or down.
- Press the control rearward or forward to move the steering wheel closer or away from you.

## Front Seat Controls



The seat switches function the same for the driver and front seat passenger.

### Upper Switch

Rotate the switch forward to raise the seatback and rearward to recline the seatback.

### Lower Switch

- Move the seat forward or rearward by sliding the control forward or rearward.
- Raise or lower the seat by moving the control up or down.

## Second Row Seat Controls – Manual

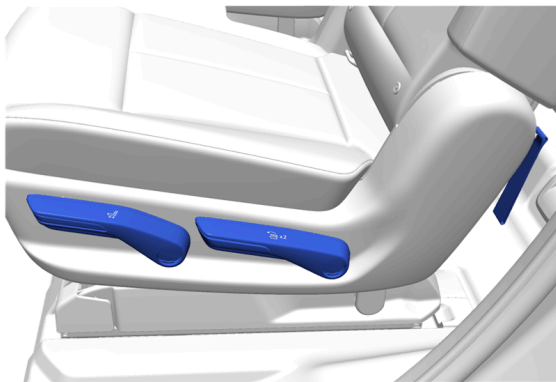

The seat controls function the same for left and right-side passengers.

### Front Lever

Lift the lever and slide the seat forward or backward.

### Rear Lever

1. Lift the lever to release the seatback. The seatback will fold forward.
2. Lift the lever again to release the rear of the seat from the floor. The seat will tumble forward.

### Rear Strap

1. Pull the strap on the back of the seat to release the seatback. The seatback will fold forward.
2. Pull the strap again to release the rear of the seat from the floor. The seat will tumble forward.

## Second Row Seat Controls – Power (Executive Seating)

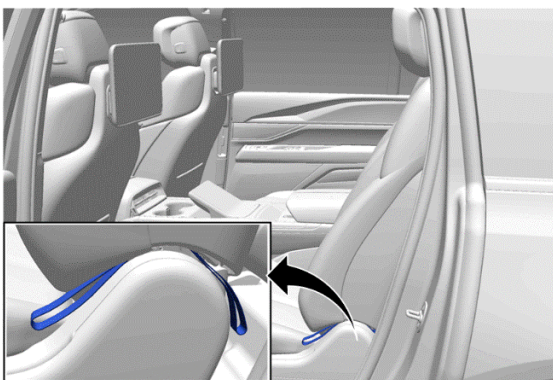

The primary controls for the executive seats are on the rear center display screen.

In the event of a power loss, an emergency strap can be pulled from the second or third row seat to incline the seat forward for exit of a person in the third row.

The seat controls function the same for left and right-side passengers.

## Occupant Restraint Systems

The Escalade IQ and IQL are equipped with seven Airbags:

- Driver
- Front Seat Passenger
- (2) Front Seat Outboard Airbags
- (1) Driver Seat Inboard Airbag
- (2) Roof Rail Airbags

There are seat belt restraints for seven occupants. The front seat belt system includes two pre-tensioners on each side.

The rear seats includes child seat anchor points:

- Top tether anchors behind the seatback
- The second row seats have lower anchors at the base of the seatback.

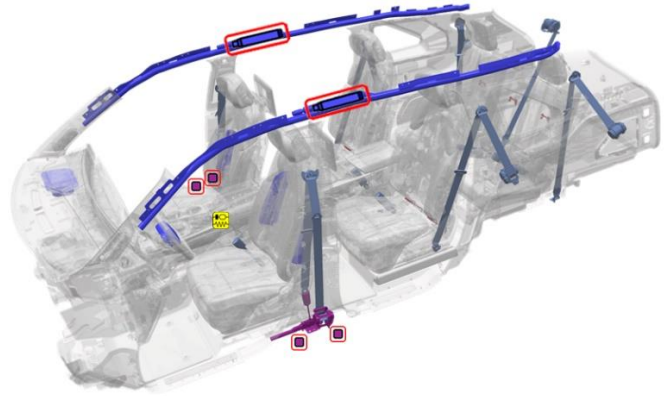



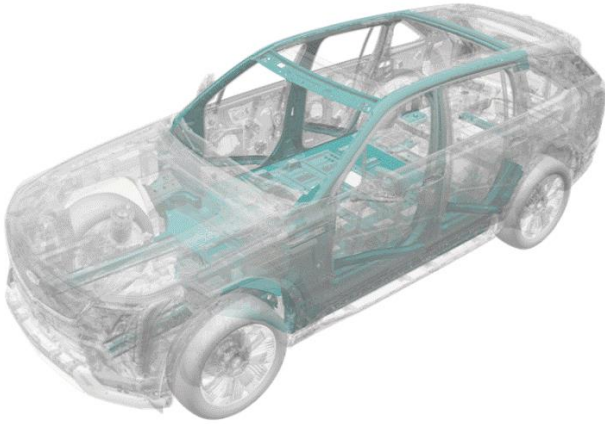



## High Strength Steel Structure



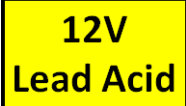







The passenger compartment is protected using high strength steel in the pillars, rocker panels, door reinforcement beams, and floor structure.



As with any occupant extrication, exercise caution. The vehicle's high voltage cables and components may be energized with high voltage. Avoid touching or cutting high voltage cables or components during any rescue operation.

5. Stored energy / liquids / gases / solids	
	Low Voltage Lead Acid Chemistry Battery
	High Voltage Lithium-Ion Chemistry Battery
	High Voltage Warning, potential for electric shock
	Gases emitted from the battery pack are flammable
	Gases emitted from the battery pack are toxic
	Skin contact may cause irritation. Prolonged contact with electrolyte mixture may result in more severe irritation. Flush contaminated skin with plenty of water.
	Coolant leaking inside the battery pack can become unstable and possibly a risk for a fire. Check the battery pack temperature using a thermal imaging camera.

6. In case of fire	
	High Voltage Warning, potential for electric shock
	A battery on fire will not explode
	A battery on fire will not explode. If battery cells reach high enough temperature, they vent and release electrolyte. Battery electrolyte is flammable.
	Gases emitted from the battery pack are toxic
	Skin contact may cause irritation. Prolonged contact with electrolyte mixture may result in more severe irritation. Flush contaminated skin with plenty of water.

	<p>Potential for eye, nose, and throat irritation with prolonged exposure.</p>
	<p>Always wear Self-Contained Breathing Apparatus (SCBA). Use copious amounts of water to cool the battery and to extinguish a fire. Do NOT use an ABC dry chemical extinguisher because it will not extinguish a battery fire.</p>
<hr/> <div style="display: flex; align-items: center;">   <div style="margin-left: 10px;"> <p style="color: red;">Potential for Battery Re-Ignition.</p> </div> </div> <hr/>	

**7. In case of submersion**

The high voltage battery is isolated from the vehicle chassis. If the vehicle is immersed in water, you will not be electrocuted by touching the vehicle.

After the vehicle was removed from the water, do the following:

1. Allow the vehicle to dry out.
2. Perform the high voltage disabling procedure in Section 3.

**8. Towing / transportation / storage**

**Front Attachment Points**

The vehicle is equipped with specific attachment points to be used to pull the vehicle onto a flatbed car carrier from a flat road surface.

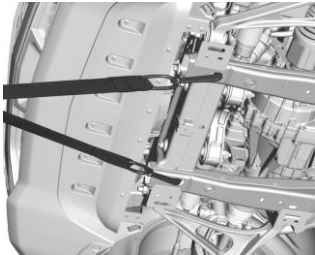
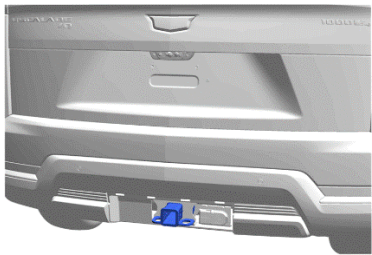
Do not use these attachment points to pull the vehicle from snow, mud, sand, or ditch.

## Vehicle Towing and Transportation

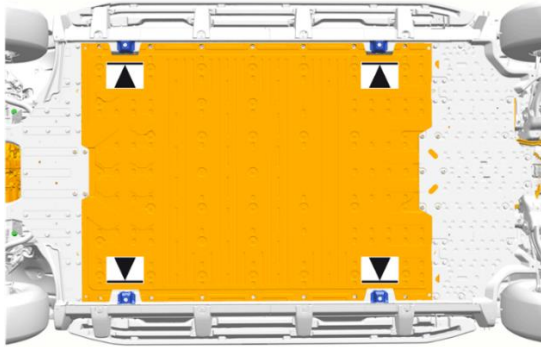

The lifting point features should only be used for lifting the vehicle. Do NOT use these features as attachment points to move or tie the vehicle down.

General Motors recommends a flatbed carrier to transport a disabled vehicle. A wheel lift truck along with properly rated tow dollies can be used if a flatbed carrier is not available.

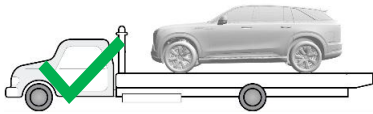

Moving the vehicle with the drive wheels on the ground will generate unwanted energy. Limit the movement of the vehicle to the distance required to prepare the vehicle for towing.



Potential for continued hazards (rekindling/re-gassing/etc) if a damaged vehicle battery is jostled during recovery, including the towing and storage process.



After a "Battery Danger Detected" notification, or thermal runaway mitigation cycle completes, it might be appropriate to wait up to an hour before towing to a certified dealer for vehicle inspection even though evidence of a thermal event such as smoke may not be visible, and unusual odors may not be detected from the vehicle.

## Horn Fuse Removal

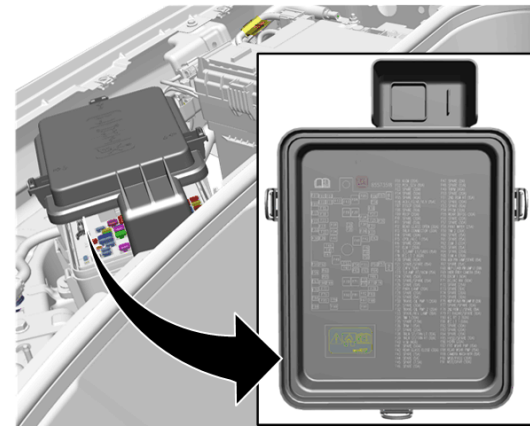

If the horn must be disabled prior to transport, locate and remove the horn fuse from the underhood electrical center.

## Post-Crash Vehicle Storage

Store the vehicle outside at a safe distance (15 meters / 50 feet) or separated from flammable objects.

## Disposal

The high voltage battery and leaked battery fluids should be properly disposed of according to local regulations. General Motors recommends removing and recycling the battery. Refer to [recyclemybattery.com](http://recyclemybattery.com) for more information on storing, disabling, removing, and shipping the battery along with a list of available recycling facilities.













## 9. Important additional information

This vehicle is supported by OnStar, where available.

This vehicle does NOT have a power button. The vehicle will turn off when shifted to P (Park) and a driver exit is detected.

The “Vehicle Off” symbol  will appear on the Infotainment Display and can be used to turn the vehicle off. If a collision is detected, an additional “Emergency Vehicle Off” symbol will appear on the display and can be pressed to turn the vehicle off. Refer to Section 3 for additional details.

## 10. Explanation of pictograms used

	Electric Vehicle		General warning sign		Warning, Electricity
	Battery Technology		Lifting Points		Thermal Imaging Camera
	Flammable		Toxic		Corrosive
	Injury Risk		Use Water		Front Compartment Release
	Cable Cut Location				